

Dimensiones

LONGITUD COLUMNA (L): 500 - 1250 mm

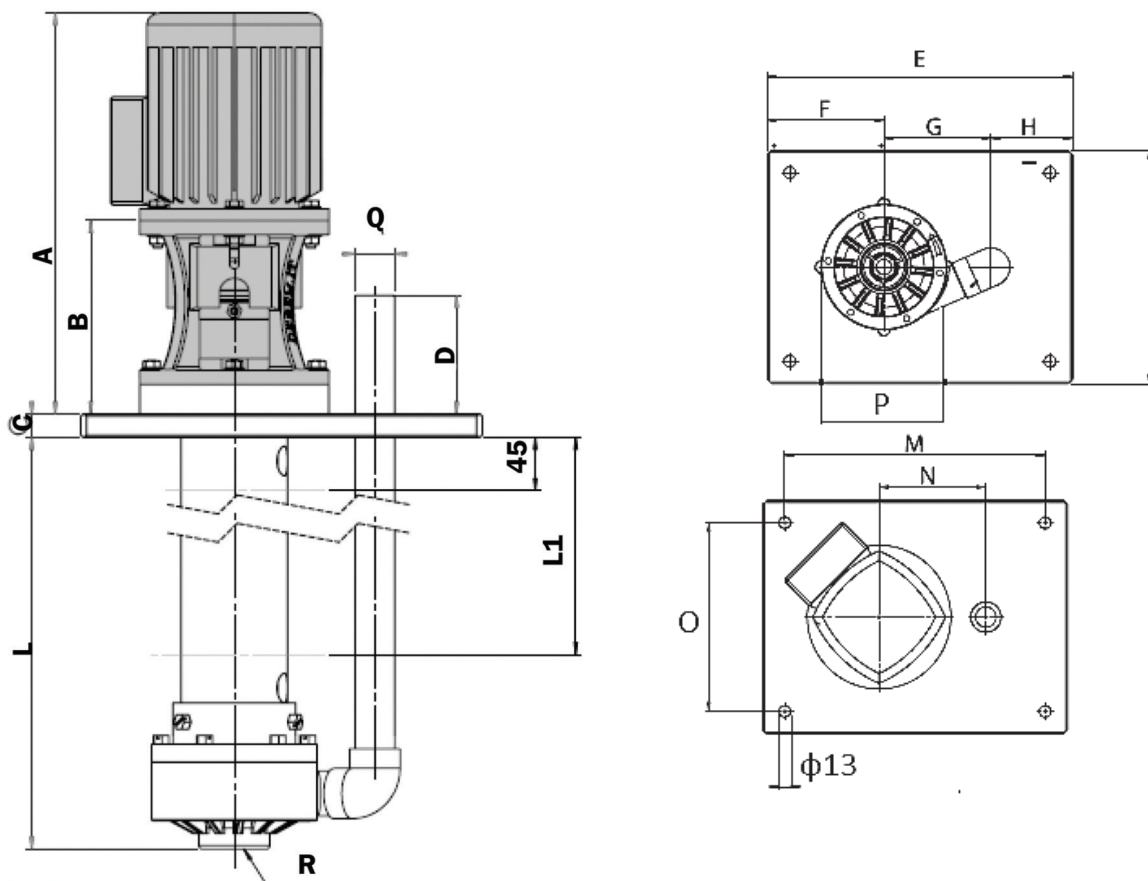

Peso del motor	17 kg
Columna peso L=500 mm	PP 15 Kg - PVDF 16 Kg
Columna peso L=800 mm	PP 19 Kg - PVDF 20 Kg
Columna peso L=1000 mm	PP 22 Kg - PVDF 23 Kg
Columna peso L=1250 mm	PP 24 Kg - PVDF 25 Kg

Tipo de bomba	Motor Flange B5	HP	Rpm	Dimensiones -mm-															
				A	B	L	C	D	E	F	G	H	I	M	N	O	P	Q	R
ADV 120	90	2.0	2800	446	220	500-1250	25	125	360	135	165	60	300	310	165	250	$\Phi 203$	1 1/2"	2'