

ATLAS WCM 42 spare part list drawing

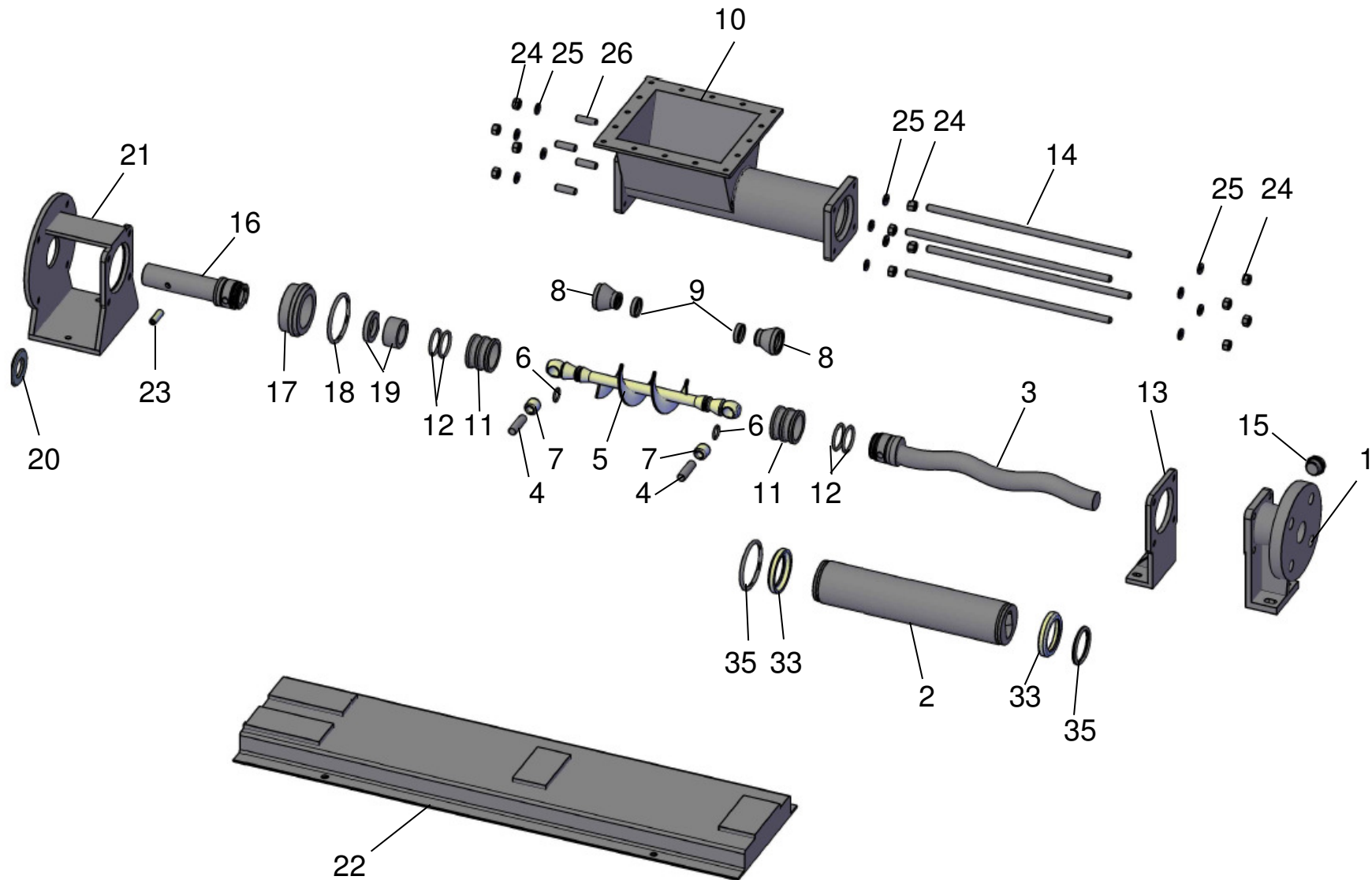

Pos	Description	Req. Qty
1	END COVER FLANGE	1
2	STATOR	1
3	ROTOR	1
4	COUPLING ROD PIN	2
5	COUPLING ROD	1
6	COUPLING ROD ORING	2
7	COUPLING ROD BUSH	2
8	BOOT SEAL	2
9	BOOT SEAL RETAINING RING	2
10	PUMP HOUSING	1
11	PIN RETAINER	2
12	SHAFT + ROTOR ORING	4
13	END SUPPORT	1
14	TIE ROD	4
15	PLUG	1

Pos	Description	Req. Qty
16	STUB SHAFT	1
17	SEAL HOUSING	1
18	SEAL HOUSING ORING	1
19	MECHANICAL SEAL	1
20	PROTECTION COVER	1
21	BRACKET	1
22	BASE	1
23	SHAFT PIN	1
24	NUT	12
25	WASHER	12
26	STUDS	4
33	STATOR SUPPORT RING	2
35	STATOR SUPPORT	2