

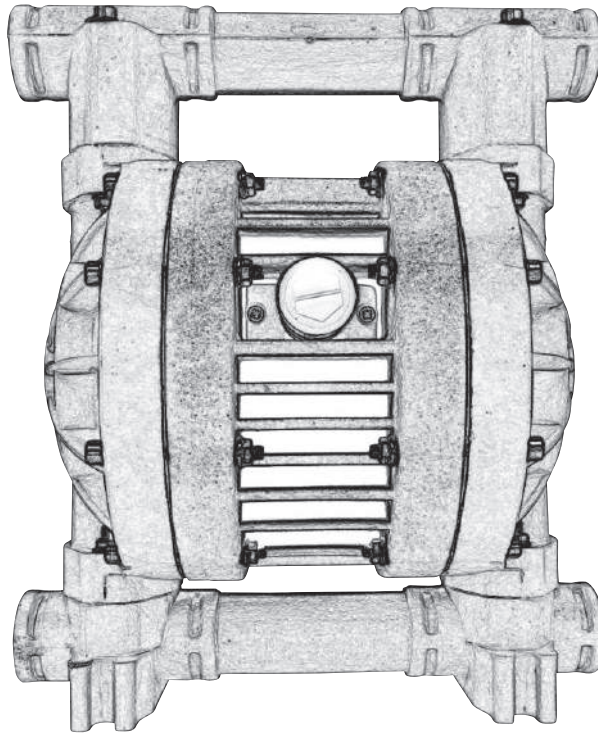

# Air Operated Diaphragm Pumps

Installation, Operation and Maintenance

## 025 Non Metallic Pump



We Make The Difference



II 2G Ex h IIB T4 Gb  
II 2D Ex h IIIB T135°C Db  
Baseefa15ATEX13DR/RN3



Industrial Park of Kifisia - HELLAS  
[www.alphadynamic.eu](http://www.alphadynamic.eu)

## INDEX

1.0	Introduction .....	5
1.0.1	Pump Identification.....	5
1.0.2	Markings and general information .....	6
1.0.3	Composition Codes .....	6
1.1	Warranty.....	7
1.2	Transport , unpacking , storage.....	7
1.3	Principle of function.....	7
1.4	Pump operation .....	8
1.5	Improper use .....	8
2.0	Safety Rules.....	8
2.1	Equipotential bonding / earthing.....	10
3.0	Installation .....	11
3.1	Connection of air supply line .....	12
3.2	Connection of suction and pressure lines .....	12
3.3	Pump in suction operation .....	12
3.4	Pump in submerged operation .....	12
3.5	Connecting to the product circuit.....	12
3.6	Noise emissions (2003/10/EC) .....	13
3.7	Temperature range of the diaphragm material .....	13
3.8	Temperature range of the Housing material .....	13
4.0	Pump Disassembly .....	14
4.1	Air control valve disassembling .....	14
4.2	Air control valve assembly.....	15
4.3	Extracting shaft Bearing .....	15
4.4	Assembling Diaphragm installation .....	16
5.0	Troubleshooting.....	17
6.0	Technical data .....	18
6.1	Dimensional Drawings .....	18
6.2	Performances .....	19
6.3	Exploded View and Spare Parts List.....	22
6.3.1	Exploded view - Ruby 025 Non Metallic Pump .....	22
6.3.2	Spare Part list .....	23
6.3.2	Spare Part list .....	23



# QMSCERT®

Certification Body



## TECHNICAL FILE REVIEW REPORT

According to the requirements of Directive 2006 / 42 / EC

Report Nr: 221.01015 Date: 16.01.2015  
Manufacturer: ALPHADYNAMIC

3 Eleftherias str, 14564  
Kifisia Industrial Park - Hellas

Applicable Design Code: EN ISO 12100:2010,  
EN 809:1998+A1:2009

Description: AIR – OPERATED DIAPHRAGM PUMP

Type : RUBY 010, RUBY 012, RUBY 015, RUBY 020, RUBY 025, RUBY 040  
(according to technical file) RUBY 050, RUBY 051, RUBY 080, RUBY 081, RUBY 115,  
RUBY 120, RUBY 125, RUBY 140, RUBY 150, RUBY 180

Technical Characteristics: Maximum Operating Pressure: 8 bar(g)  
(according to technical file) Minimum Operating Pressure: 2 bar(g)  
Maximum Operating Temperature: -10 °C up to 130 °C  
(limits according to diaphragm material)  
Maximum Operating Temperature: -25 °C up to 130 °C  
(limits according to housing material)  
Maximum Noise Level: 70 – 80 db.  
Maximum Viscosity: 50.000. cPa.s

The manufacturer in accordance with Annex VII of the Directive 2006/42/EC and article 12 § 2\* has compiled and submitted for review to the QMSCERT, the technical construction file of the above mentioned machinery. \*(Guide to application of the Machinery Directive 2006/42/EC 2<sup>nd</sup> edition 2010 §128)

The technical construction file was evaluated and found to be in accordance with Annex VII §A .1 of the Directive 2006/42/EC. The present report is an integral part of the technical file of the machinery and cannot be use as certificate.

This report must be kept with its technical documentation by the manufacturer for a period of ten years. The applicant must inform QMSCERT which reviewed the technical documentation of all modifications to the technical file of equipment.

These are subject to additional review where they may affect conformity with the essential requirements or the prescribed conditions for use of the equipment. This additional review will be given in the format of issuing a new report.

This review of the Technical File has been carried out to the best knowledge and ability and our responsibility is limited to the exercise of due care and the results concern only the items inspected.



For QMSCERT

Dimitrios Papadopoulos

Lead Auditor M.Sc. Dipl. Mechanical Eng.  
Dr. Welding Eng.- Level II RT , MT , PT , UT

# EC Declaration of Conformity



II 2G Ex h IIB T4 Gb  
II 2D Ex h IIB T135°C Db  
Baseefa15ATEX13DR/RN3

**Manufactured By: ALPHADYNAMIC PUMPS Co.**  
3 Eleftherias Str 14564 - Kifisia -Greece  
Tel + 30 215 215 9520 -Fax +30 211 2686837



Type of protection: Constructional Safety "c"

This declaration applies to all Metallic & Conductive Plastic Ruby Air Operated Double Diaphragm pumps.  
ALPHADYNAMIC PUMPS (HELLAS) declares under our sole responsibility that the product listed below conforms with the relevant provisions of EC directive 2014/34/EC for equipment and protective systems intended for use in potentially explosive atmospheres, and is self certified for safe use in ATEX Group II, Category 2 area's.

We hereby declare, that the following pump units manufactured in series production  
Part numbers:

- A010-1003-E to A010-1003-T, A010-1103-E to A010-1103-T, A012-1003-E to A012-1003-T, A012-1103-E to A012-1103-T
- A010-1159-E to A010-1165-F
- A015-1001 to A015-1012-E, A015-1051 to A015-1067-T, A015-1069-E to A015-1070, A015-1072-E to A015-1072-T
- A015-1081-E to A015-1086-E, A015-1101 to A015-1111-E, A015-1151 to A015-1182-T
- A115-1003-E to A115-1017-F, A115-1043-F to A115-1090-T, A115-1103-F to A115-1119-F
- A020-1001 to A020-1017-F, A020-1051 to A020-1067-T, A020-1069-E to A020-1070, A020-1072-E to A020-1072-T
- A020-1081-E to A020-1086-E, A020-1101 to A020-1111-E
- A120-1043-T to A120-1091-N
- A025-1001 to A025-1017-E, A025-1051 to A025-1067-T, A025-1069-E to A025-1070, A025-1072-E to A025-1072-T
- A025-1081-E to A025-1086-E, A025-1101 to A025-1119-F, A025-1151 to A025-1180-F, A025-2051 to A025-2064-N
- A025-2066-E to A025-2067-T, A025-2069-E to A025-2070, A025-2072-E to A025-2072-T, A025-2081-E to A025-2083-T
- A025-2151 to A025-2180-F
- A125-1043-F to A125-1092-N, A125-2043-F to A125-2092-N
- A040-1001 to A040-1017-F, A040-1051 to A040-1067-T, A040-1069-E to A040-1070, A040-1072-E to A040-1072-T
- A040-1081-E to A040-1086-E, A040-1101 to A040-1119-F, A040-1151 to A040-1180-F, A040-2051 to A040-2064-N
- A040-2066-E to A040-2067-T, A040-2069-E to A040-2070, A040-2072-E to A040-2072-T, A040-2081-E to A040-2083-T
- A040-2151 to A040-2180-F
- A140-1043-F to A140-1092-N, A140-2043-F to A140-2092-N,
- A050-1051 to A050-1052, A050-1054-E to A050-1054-T, A050-1056-E to A050-1056-T, A050-1058, A050-1061-E to A050 1066-T
- A050-1070, A050-1072-E to A050-1072-T, A050-1081-E to A050-1081-T, A050-1083-E to A050-1086-E,
- A050-1151 to A050-1180-F, A050-2151 to A050-2180-F
- A051-1003, A051-1007 to A051-1014-N, A051-1103-T
- A150-1043-F to A150-1092-N, A150-2043-F to A150-2092-N
- A080-1051 to A080-1086-E, A080-1151 to A080-1180-F, A080-2151 to A080-2180-F
- A081-1003 to A081-1014-N, A081-1103-F, A081-1103-E
- A180-1043-F to A180-1092-N, A180-2043-F to A180-2092-N

in the version delivered by us, is in compliance with the following applicable regulations:

- EC Directive 2014/34/EC Equipment and protective systems intended for use in potentially explosive atmospheres (ATEX)
- EN ISO 80079-36 :2106 Non-electrical equipment for use in potentially explosive atmospheres - Basic method and requirements
- EN ISO 80079-37:Non electrical equipment for explosive atmospheres – No electrical type of protection by constructional safety "c", control of ignition source "b", liquid immersion "k"
- Machinery Safety Directive: 2006/42/EC
- IEC 60079-0 Explosive atmospheres - Equipment General requirements

Signature of manufacturer:

Date : 30/10/2019

Information on signatory : Nikolaos Prodromidis

## 1.0 Introduction

Ruby pumps have been manufactured to the 2006/42/CE, 2014/34//EC directives. The relevant area criteria are indicated in the EN-60079-10, EN-12100:2010, EN-809:1998+A1:2009, EN-80079-36, EN 80079-37 harmonized European standards. Therefore, if used according to the instructions contained in this manual, the Ruby pumps will not represent any risk to the operator. This manual must be preserved in good condition and/or accompany the machine as reference for maintenance purposes. The manufacturer rejects any liability for any alteration, modification, incorrect application or operation not complying with the content of this manual and that may cause damage to the health and safety of persons, animals or objects stationing near the pumps

The following instructions solely refer to Ruby Air Operated Diaphragm Pumps. Since the pumps are used in combination with other assemblies, such as solenoid valves, sensors or pulsation dampers, the valid operating instructions for these components and the associated notes on safety must also be taken into account.

These instructions contain information on safety, installation, operation, maintenance, repair and environmental waste disposal of the Ruby Air Operated Diaphragm Pump. Thoroughly read these instructions before use and always follow the information contained therein.

Persons entrusted with the installation, operation, maintenance or repair of the pump must have read and understood these instructions, especially the chapter on "Health and Safety". This applies in particular for those who are only occasionally involved in work on the pump, like cleaning or service personnel.

Each pump is subjected to stringent inspections and function tests before leaving the factory.

You should always bear in mind that a correct function, a long lifetime and optimal operational reliability of the pump mainly depend on

- correct installation
- correct commissioning
- and correctly performed maintenance and repair work.

Enquiries concerning service, spare parts or repairs should be addressed to the manufacturer

Always provide the following information:

- Series
- Pump size
- Serial number of pump

This information is stamped on the identification plate on top of the pump.

### Danger!

**When returning pumps or pump parts to your supplier for repair or general overhaul, the delivery must be accompanied by certificates stating that pumps or pump parts are free of product and other aggressive or hazardous substances.**

#### 1.0.1 Pump Identification

Each pump has an identification plate carrying its specification details and materials.

Always refer to this data when contacting the manufacturer, dealer or customer service centers.

### WARNING: removing or altering this identification plate and or the data it contains is forbidden.

Identification code on the plate against the "TYPE" heading specifies the composition and the materials used to build the pump. This data will help ascertain whether the pump is suitable for the product to be pumped.

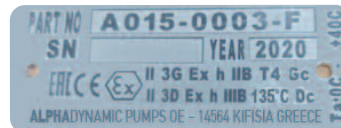
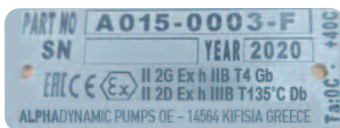

### 1.0.2 Markings and general information

In compliance with the 2014/34/EC standards, the Ruby pumps carry the following identification marks:

- EC Directive 2014/34/EC Equipment and protective systems intended for use in potentially explosive atmospheres (ATEX)
- EN ISO 80079-36 :2106 Non-electrical equipment for use in potentially explosive atmospheres - Basic method and requirements
- EN ISO 80079-37:Non electrical equipment for explosive atmospheres – No electrical type of protection by constructional safety "c", control of ignition source "b", liquid immersion "k"
- Machinery Safety Directive: 2006/42/EC
- IEC 60079-0 Explosive atmospheres - Equipment General requirements

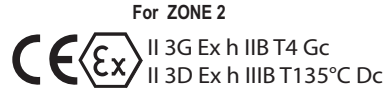
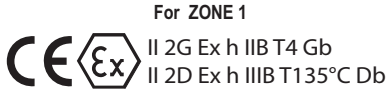

### 1.0.3 Composition Codes

## Ruby Pumps composition codes

Model	Pump Body	Center Section	Diaphragms	Ball Seats	Valve Ball	Other Options
MINI 005 MINI 017 Ruby 010 Ruby 012 Ruby 015 Ruby 115 Ruby 020 Ruby 120 Ruby 025 Ruby 125 Ruby 040 Ruby 140 Ruby 050 Ruby 150 Ruby 051 Ruby 080 Ruby 081 Ruby 180	P: PP V: PVDF+CF A: Aluminum S: Stainless Steel 316 PC: PP+CF	P: PP A: Aluminum PC: PP+CF W: PP FDA	N: NBR Conductive E: EPDM Conductive F: VITON Conductive T: PTFE+back up (EPDM Conductive) Z: PTFE A+back up (EPDM Conductive) ST: PTFE+back up (SANTOPRENE) HY: PTFE+ back up (HYTREL) NT: PTFE+Back up (NBR)	V: PVDF S: AISI 316 T: PTFE A: Aluminum P: PP N: NBR E: EPDM O: POM-C	T: PTFE S: AISI 316 N: NBR E: EPDM N: NBR	F: Flange PN10/ANSI150 D: Twin Manifold

## 1.1 Warranty

The correct function of each Ruby pump is tested in the factory.

However, should any defect appear, please contact the Manufacturer's After-Sales Service, your dealer or the nearest Customer Service Centre where you will receive assistance as quickly as possible. In any case, please provide:

**A- Your complete address**

**B- Pump identification**

**C- Explosion risk protection class**

**D- Anomaly description**

All **Ruby** pumps are covered by the following warranty:

1. Five years for any faulty mechanical parts. The warranty period starts from the date of supply.
2. Any fault or anomaly must be reported to the the Manufacturer within eight days.
3. Warranty repair will be carried out exclusively at the Manufacturer's premises. Transportation charges will be at the client's expense.
4. Warranty shall not be extended in case of repair or replacement.
5. Faulty parts must be forwarded to the Manufacturer who reserves the right to test them in this own factory to identify the fault or any external reason that may have caused it. Should the parts be found not faulty, the Manufacturer reserves the right to invoice the total cost of the parts that had been replaced under this warranty.

Costs and transportation risks of faulty, repaired or replaced parts including custom charges will be borne entirely by the client.

Repair or replacement of faulty parts cover any obligation under this warranty.

The warranty **DOES NOT** cover any indirect damage and in particular any normal consumable material such as diaphragms, ball seats, balls and others.

The warranty does not cover parts damaged as a consequence of incorrect installation, carelessness, neglect, incorrect maintenance, or damages due to transportation or to any other reason or event that is not directly linked to functional or manufacturing defects.

**The warranty excludes all cases of improper use of the pump or incorrect applications or non-observance of the information contained in this manual.**

**Any controversy falls within the jurisdiction of the Court of Athens.**

## 1.2 Transport, unipacking, storage

In order to avoid any problems you should check the delivered goods against the delivery note for completeness and correctness.

Be careful when unpacking the pump and proceed as follows:

- Check the packaging material for transport damage.
- Take the pump carefully out of the packaging material.
- Check the pump for visual damage.
- Remove the plugs from all pump ports.
- Check seals and fluid lines for damage.

The following points must be strictly observed when preparing the pump for storage:

- Store the pump in a dry place.
- Thoroughly clean used pumps before storage.
- Do not subject stored pumps to extreme temperature fluctuations.

## 1.3 Principle of function

- 1 Discharge manifold
- 2 Top valve ball (closed during suction)
- 3 Diaphragm
- 4 Pump chamber
- 5 Bottom valve ball (opened. Medium flows into chamber)
- 6 Top valve ball (open. Product is pressed out)
- 7 Center Block (the drive air displaces the medium via the diaphragm and at the same time pulls back the second diaphragm)
- 8 Bottom valve ball (closed during delivery)
- 9 Suction manifold
- 10 Air control unit
- 11 Air valve drive

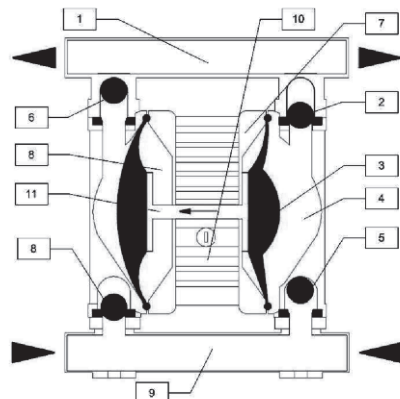

fig.2 Design of pump

## 1.4 Pump operation

Ruby Air Operated Diaphragm Pumps are oscillating positive displacement pumps with two pump chambers arranged opposite each other. Both of these are separated by a diaphragm each into an air and a fluid section.

Both diaphragms are linked by a piston rod, so that with every stroke product is displaced to the outside from the one pump chamber and product is drawn into the opposite pump chamber.

## 1.5 Improper use

Particularly, it is **FORBIDDEN** to use Ruby pumps for :

- production of vacuum;
- operation as an on-off valve, as a non-return valve or as a metering valve
- operation with liquid that is chemically incompatible, with the materials of construction;
- operation with suspended products whose specific weight is higher than the liquid's (for example with water and sand) .
- With with air pressures, temperatures or product characteristics that do not comply with the pump's technical data .

**⚠ WARNING:** since an endless variety of products and chemical compositions exist, the user is presumed to have the best knowledge of their reaction and compatibility with the pump's construction materials. Therefore, before using the pump, all necessary checks and tests must be performed with great care to avoid even the slightest risk, an event that the manufacturer cannot foresee and for which he cannot be held responsible.

**⚠ WARNING:** the user must consider the ratio between the pump's maximum surface temperature indicated on the marking and the minimum ignition temperature of the layers and clouds of powder as shown in the EN1227-1.

**⚠ WARNING:** Use of the pump that does not comply with the instructions indicated in the use and maintenance manual will cancel the safety and explosion protection requirements. The risks associated with use of the pumps under the exact conditions set forth in the use and maintenance manual have been analysed, whilst the analysis of the risks associated with the interface with other system components must be carried out by the installer

The user is responsible for classifying the area of use whilst identification of the equipment category is the responsibility of the manufacturer

## 2.0 Safety Rules

Dangerous or hazardous practices or practice not complying with the safety rules and with the recommendations contained herein, may cause serious injuries, material damage and even explosions and /or death for which the manufacturer cannot be held responsible.

**⚠ WARNING:** these instructions are essential for the pumps' compliance to the requirements of the 2006/42/EC directive and must therefore be available, known, understood and applied.

**⚠ WARNING:** the personnel in charge of installing, inspecting and servicing the pumps must have suitable technical knowledge and training in matters concerning potentially explosive atmospheres and the related risks

**⚠ WARNING:** use of the pumps in a manner that does not comply with the instructions indicated in the use and maintenance manual will cancel all the requirements for safety and protection against of explosions.

**⚠ WARNING:** before intervening on the pump and/or servicing or repairing it, please- note that you must:

- A - Discharge any product that was being pumped
- B - Wash it internally using a suitable non-flammable fluid, then drain.
- C - Cut-off the air supply using the relevant valve and make sure that no residual pressure remains inside it.
- D - Close all on-off valves {delivery and intake sides} relative to the product.
- E - Disconnect the network air supply;
- F - Wear suitable individual protection before any maintenance or repair (goggles / face protection, gloves, closed shoes, aprons and others).

**⚠ WARNING:** before using the pump, make sure that the fluid to be pumped is compatible with the explosion protection class and with construction materials of the pump.

**DANGER OF CORROSION, PRODUCT SPILLS AND/ OR EXPLOSIONS CAUSED BY CHEMICAL REACTIONS**





For installation and use in a potentially explosive environment, comply with these general precautions

- ascertain that the pump is full and if possible, that the level is above it by 0.5 m;
- ascertain that the fluid treated does not contain or cannot contain large solids or solids of a dangerous shape
- ensure that the intake or delivery ports are not obstructed nor limited to avoid cavitation or pneumatic motor strain.
- also ascertain that the connection piping is strong enough and cannot be deformed by the pump weight or by the intake. Also check that the pump is not burdened by the weight of the piping
- If the pump is to stay in disuse for a long period of time, clean it carefully by running a non-flammable liquid detergent through it that is compatible with the pump's construction materials
- if the pump was turned off for a long period of time, circulate clean water in it for some minutes to avoid incrustations.
- before starting, after long periods of disuse, clean the Internal and external surfaces with a damp cloth;
- check the grounding;
- always protect the pump against possible collisions caused by moving objects or by various blunt materials that may damage it or react with its materials;
- protect the pump's surrounding ambient from splashes caused by accidental pump failure;
- if the diaphragms are completely torn, the fluid may enter the air circuit, damaging it, and be discharged from the exhaust port. It is therefore necessary for the exhaust port to be conveyed by pipes to a safe area.

 **WARNING:** the air supply pressure must never be over 7 bar or below 2 bar

 **WARNING:** when using the pump with aggressive or toxic liquids or with liquids that may represent a health hazard you must install suitable protection on the pump to contain, collect and signal any spills: **DANGER OF POLLUTION, CONTAMINATION, INJURIES AND/OR DEATH.**

 **WARNING:** the pump must not be used with fluids that are not compatible with its construction materials or in a place containing incompatible fluids.

 **WARNING:** installing the pumps without on/off valves on the intake and delivery sides to intercept the product in case of spillage is forbidden: danger of uncontrolled product spillage

 **WARNING:** installing the pumps without on-off, three way or check valves on the air supply piping to prevent the pumped liquid from entering the pneumatic circuit if the diaphragms are broken is forbidden: danger of fluid entering the compressed air circuit and being discharged into the environment

 **WARNING:** Should the user think that the temperature limits set forth in this manual may be exceeded during service, a protective device must be installed on the system to prevent the maximum allowed process temperature from being reached.

If exceeded, respect of the maximum temperature marked cannot be guaranteed

 **WARNING:** The pumps must always be grounded irrespective of any organ to which they are connected. Lack of grounding or incorrect grounding will cancel the requirements for safety and protection against the risk of explosion

 **WARNING:** the use of pumps made with non-conductive material, which become charged with static, and without suitable grounding for flammable liquids is forbidden: **RISK OF EXPLOSIONS DUE TO STATIC CHARGE**

 **WARNING:** Aggressive, toxic or dangerous liquids may cause serious injuries or damage to health, therefore it is forbidden to return a pump containing such products to the manufacturer or to a service center. You must empty the internal circuits from the product first and wash and treat it.

 **WARNING:** Pumps containing aluminium parts or components coming into contact with the product cannot be used to pump III-trichloroethane, methylene chloride or solvents based on other halogenated hydrocarbons:

#### **DANGER OF AN EXPLOSION CAUSED BY A CHEMICAL REACTION**

 **WARNING:** Conductive Polypropylene, conductive PVDF pumps are not to be installed in applications where the pumps may be subjected to oil, greases and hydraulic liquids

**⚠ WARNING:** The components of the pneumatic exchanger, including the shaft are made from materials that are not specifically resistant to chemical products, if the diaphragm should break, replace these elements completely if they have come into contact with the product

**⚠ WARNING:**The air-driven motor of the Ruby pumps is self-lubricating and will not require any greasing. Therefore avoid using lubricated and non-dried air.

**⚠ WARNING:** ascertain that during service no anomalous noise appears. In that case, stop the pump immediately

**⚠ WARNING:** ascertain that the fluid at the delivery side does not contain gas. Otherwise stop the pump immediately

**⚠ WARNING:** Periodic controls must be made to ensure that there is no powder and/or deposits on the external and internal surfaces of the pump and, if necessary, they must be cleaned with a damp cloth

**⚠ WARNING:** removal of the silencer and the air supply fitting must be done when free from powder. Before restarting the pump, ensure that no powder has entered the pneumatic distributor.

To replace worn parts, use only original spare parts.

Failure to comply with the above may give rise to risks for the operator, the technicians, the persons, the pump and/or the environment that cannot be ascribed to the manufacturer.

**⚠ WARNING:** diaphragm pumps with negative suction are affected by the following factors:

-viscosity and specific weight of the fluid;

-suction diameter and length.

Position the pump as close as possible to the point of collection (within 2.5 m.) and in any case never more than 5 m. The diameter of the intake pipe must never be smaller than the connection of the pump, but must be increased as the distance increases. Fluid to be pumped with negative suction must never exceed a viscosity of 5.000 cps at 20° C and a specific weight of 1.4 Kg/l. These elements can cause derating and reduce the duration of the diaphragm: **DANGER OF PREMATURE BREAKAGE.**

## 2.1 Equipotential bonding / earthing

In principle, pumps and accessories must be earthed or provided with equipotential bonding if there is the possibility of product specific electro-static charging and when used in potentially explosive areas. Pumps and pulsation dampers with ATEX II 2G Ex h IIB T4 Gb -- II 2D Ex h IIB T135 Gb approval are therefore fitted with an earthing screw.

**Please Pay attention**

### For Zone 1

- Aluminum in combination with stainless steel (greater or equal 16,5% Cr) is only be used if the steel cannot corrode and no iron oxide and/or rusty particles can be deposited on the surface. (appropriate reference to the properties of the stainless steel shall be given in the technical documentation and instruction for use.
- For Pumps with diaphragm type TFM:
  1. Not run empty with flammable fluid/gas.
  2. Flush before

### For Zone 2

1. Not run empty with flammable fluid / gas.
2. Flush before

**⚠ WARNING:** the use of pumps made with non-conductive material, which become charged with static, and without suitable grounding for flammable liquids is forbidden:

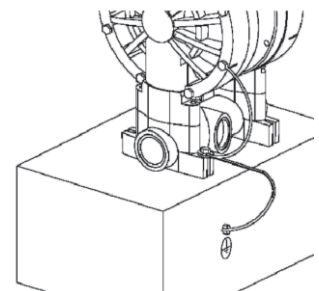

**RISK OF EXPLOSIONS DUE TO STATIC CHARGE**

### 3.0 Installation

#### To be observed before installation

1. The installation must only be carried out by persons who have the necessary skills for this work
2. Before installation align the pump correctly and fasten it without any tension. Pipelines must be assembled in a way that the basic weight of the lines is not resting on the pump
3. In order to avoid damage to the pump new installations should generally be checked for any debris (welding beads, pieces of wire, etc.) in tank and pipeline system.
4. Consider the arrangement of the pump with respect to suction and discharge heads.
5. The pump system must be designed according to the requirements of the application. Valves or spools must be installed as close as possible to pressure port. This also applies for T-fittings with valve for bypass control or pressure relief valves, pressure gauges, flow control valves and shut-off valves.
6. Thoroughly examine the alignment of the pump with the pipelines, in order to avoid strain and premature wear.
7. Check all pipelines for leaks. This applies in particular for the suction line, in order to avoid the intake of air.
8. If the fluid to be pumped contains solid particles bigger than specified, a filter must be installed. The filter must be of such a size, that the change in resistance at the pump inlet port is only minor. This filter must be permanently monitored and, if necessary, cleaned.
9. Fluids which change their viscosity must be permanently agitated, or the tank must be fitted with a temperature sensor. With increasing viscosity start the agitator and/or the heating. This is of special importance for intermittent operation!

**Note:** It is recommended to install flexible, shape and pressure resistant hoses or compensators at the suction and pressure ports of the pump (Fig. 3). This will prevent the transfer of pulsation shocks into the pump.

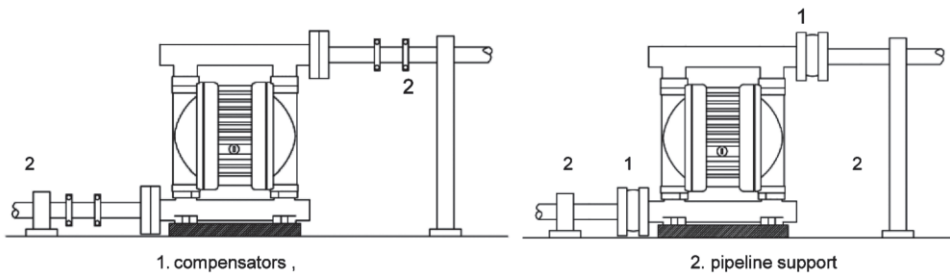
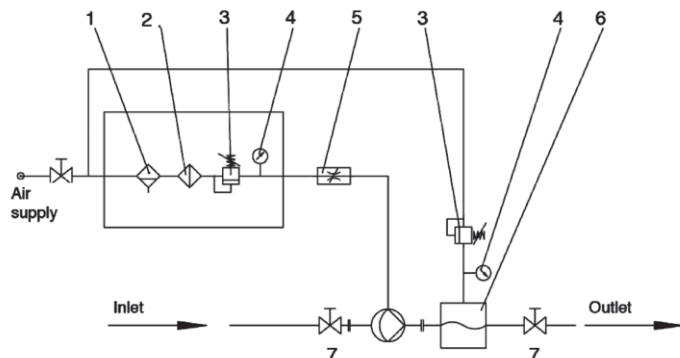



Fig 3. Installation proposal for diaphragm pump

1. Water separator
2. Filter
3. Pressure reducer
4. Pressure Gauge
5. Needle valve
6. Pulsation dampener
7. Shut-off elements on Suction and pressure side.



### 3.1 Connection of air supply line

We recommend to supply the air through a hose to the pump. Using moisturized compressed air requires the installation of a service unit with water separator. This control equipment can additionally be used to regulate the flow capacity of the pump. The diaphragm must not be subjected to shockloads. For this reason we recommend the installation of a spool, diaphragm or needle valve as shut-off element.

 **WARNING: pneumatic supply to the Ruby pumps must be made using FILTERED. DRIED. NON LUBRICATED OIL FREE AIR at a pressure of not less than 2 bars and not more than 7 bars.**

 **WARNING: do not remove RESET for any reason and/or do not connect the air supply to the RESET channel**

 **Warning! Do not use a ball valve as shut-off element**

**Note: Especially for plastic pumps or pumps with PTFE diaphragms it is highly recommended to install a slow start valve in the supply line to the pump. This valve protects both the diaphragm and housing parts against suddenly occurring pressure shocks.**

### 3.2 Connection of suction and pressure lines

Suction and pressure lines must be installed in a way that no additional loads are applied to the pump ports.

The tightening torque of the mounting screws and the pressure strength of the sockets and flanges must be observed with the installation of the suction and pressure lines. After assembly check the system for leaks

### 3.3 Pump in suction operation

Ruby Air Operated Diaphragm Pumps are dry self-priming. Depending on the pump design a suction head of max. 9 m Wc can be reached, when the suction line is filled.

### 3.4 Pump in submerged operation

The Ruby Air Operated Diaphragm Pumps are suitable for submerged operation. However, it must be assured that the surrounding fluid will not attack the pump.

When installing the pump make sure that the air discharge muffler has been removed and the exhaust air is discharged from the fluid through a hose.

### 3.5 Connecting to the product circuit

After positioning the pump you can now connect it to the product circuit as follows:

 **WARNING: only fittings with cylindrical gas threads in materials compatible with both the fluid to be pumped and the pump's construction materials must be used.**

For example:

**Pump made from PP - PP fitting**

**Stainless steel pump = stainless steel fitting.**

1. On the suction and discharge manifold install a manual valve of the same diameter as the pump inlet (never smaller) to intercept the fluid correctly in case of spills and / or when servicing the pump.
2. Install the sleeves to secure the flexible hoses on both valves.

 **WARNING: the pump must be connected with FLEXIBLE HOSES REINFORCED WITH A RIGID SPIRAL of a diameter never smaller than the pump's connection. The filters or other equipment installed at the intake side must be suitably dimensioned in order to avoid pressure drops. For negative installations and/or viscous fluids, use hoses with an OVERSIZE DIAMETER, especially on the intake side. Connections using rigid pipes may cause strong vibrations and break the manifolds**

3. Connect the product intake and delivery hoses to their respective fittings whilst taking into consideration the signs on the pump:

"IN" = INTAKE (down) and

"OUT" = DELIVERY (up)

or according to that indicated by the arrows.

4. Secure the hoses using the relevant clamps.

 **WARNING: Provide appropriate support for the piping. THE PIPING MUST BE STRONG ENOUGH TO AVOID DEFORMATION DURING THE SUCTION PHASE AND MUST NEVER WEIGH DOWN ON THE PUMP IN ANY WAY OR VICE VERSA .**

5. If used for drum suction (not below head), the submersed end of the intake hose must be provided with a diagonally cut fixing to prevent it from adhering to the drum bottom.

 **WARNING: Ascertain that the fluid treated does not contain or cannot contain large solids or solids of a dangerous shape and that the intake or delivery ports are not obstructed nor limited to avoid either cavitation or pneumatic motor strain.**

Connection off the product circuit finishes here.

### 3.6 Noise emissions (2003/10/EC)

In a room with several pumps you may experience an extreme development of noise . Depending on the sound pressure level the following measures must therefore be applied:

Below 70 dB (A) : No special measures required

Above 70 dB (A) : Persons who are permanently in the room must wear ear defenders.

Above 85 dB (A) : Room with dangerous noise level!! Each door must have a clearly noticeable warning sign to warn persons from entering the room without ear defenders.

### 3.7 Temperature range of the diaphragm material

TFM Compound Diaphragm: -10° C - 130° C

NBR Conductive Diaphragm: -10° C - 100° C

TFM Full capacity Compound Diaphragm: -10° C - 130° C

EPDM Conductive Diaphragm: -10° C - 100° C

VITON Conductive diaphragm : -40° C - 170° C

### 3.8 Temperature range of the Housing material

Stainless steel: -25° C - 130° C

Aluminium: -10° C - 130° C

Polypropylene: 0° C - 60° C

PVDF + CF: -10° C - 120° C

## 4.0 Pump Disassembly



**Step 1**  
Remove the discharge manifold by untying the screws in X formulation



**Step 2**  
Remove the balls and the seats. Reverse the pump and remove the suction manifold with the same way



**Step 3**  
Untie one of the two housings, by untying the screws gradually and cyclically.



**Step 4**  
Detach the diaphragm from the central block by hand and untie it with a left rotation.



**Step 5**  
Untie the opposite housing and pull the diaphragm along with the shaft outwards. Remove the diaphragm from the shaft

## 4.1 Air control valve disassembling



**Step 1 - Step 2**  
We remove the safeties (step 1) and push from the one side the air control unit towards the outer part (step 2)

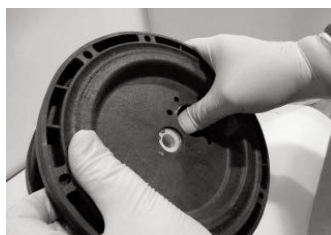

## 4.2 Air control valve assembly



**Step 1**  
We put the valve without the lateral caps at the nest after we put PG21 MOLYCOTE both at the nest and at the valve



**Step 2**  
we push it until it comes at the same surface with the central block.

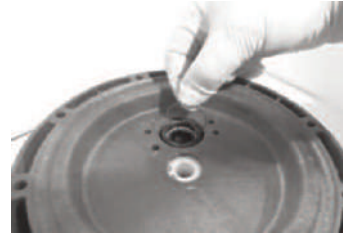

**Step 3**  
We put the sealing o-ring of the lateral cap



**Step 4**  
We install the pilot shaft

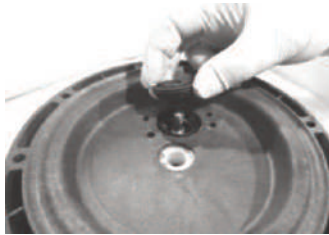

**Step 5**  
Then we install the cap up to the safety point.

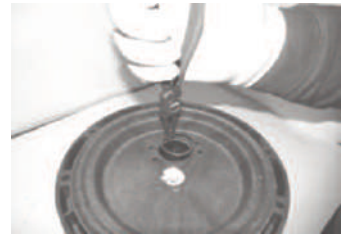

**Step 6**  
Then we install the safety, we reverse the central block, we put the second o-ring, the second cap and the second safety

## 4.3 Extacting shaft Bearing

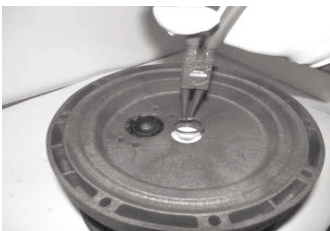

**Step 1**  
From one side we pull out the safety of the central bearing and we extract the bearing.



**Step 2**  
The same is repeated also on the other side.

## 4.4 Assembling Diaphragm installation

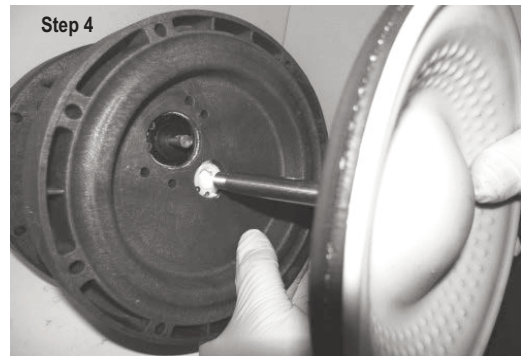
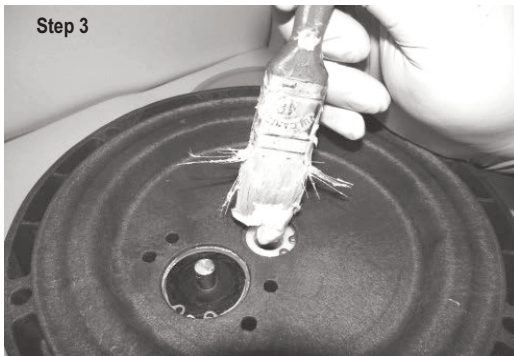
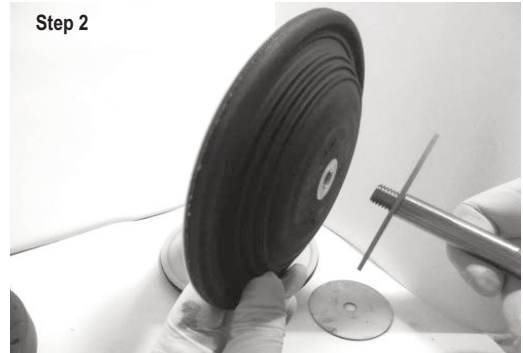
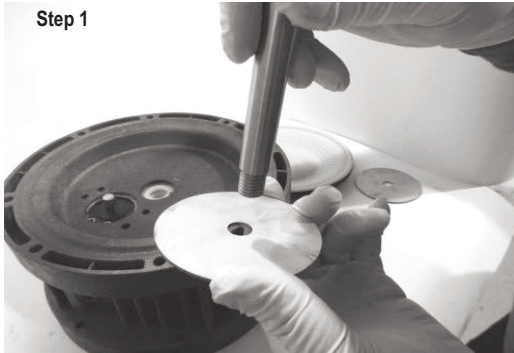

### Step 1

We put the air valve drive from the one side.

### Step 2

After, we will must screwed the shaft at the diaphragm.

### Step 3

We put PG MOLYCOTE 21 at the center of the bearing.

### Step 4

We import the shaft at the bearing from that side where we put PG MOLYCOTE 21. We push the shaft so that it passes on the other side. After we do that, we clean the PG MOLYCOTE 21 that has remained. From the opposite side we install the air valve drive and we have the diaphragm screwed.

### Step 5

We put at the pump air entrance, air of 0.5 bar pressure and we see in which side of the block, the entrance holes at the back of the diaphragm are releasing air.

We remove the air. We assemble the housing at that side where the holes of the valve are releasing air.

We tighten the screws in a peripheral way, one after the other, step by step, so that the gap that we achieve between housing and central block is 1.5 mm up to 2 mm.

You install the air tube at the pump entrance and you turn on the air at 0,5 bar.

The diaphragm will retreat. Then install the housing and have it screwed the same way.





## 5.0 Troubleshooting

The following instructions are intended exclusively for authorised skilled maintenance engineers. In event of abnormal behaviour and in order to fix faults, please refer to the following troubleshooting instructions.

**⚠ WARNING: For more serious problems, we strongly recommend that you contact the ALPHADYNAMIC PUMPS Co: our engineers will provide you assistance as quickly as possible.**

Fault	Possible cause	Remedy
Pump running, no delivery	Pump draws in air Suction valve closed Suction capacity exceeded Valve ball and seat on suction side worn	Seal the suction line Open valves Change the arrangement Replace seats and balls
Insufficient pumping capacity	Muffler clogged Air inlet filter clogged Insufficient air supply Pipelines blocked Viscosity too high	Clean or renew Clean or renew Check supply line Clean Change conditions
Pump slows down, stops, restarts	Icing of the control valve	Use dry air. Supply the air with anti-freeze
Reduced flow, stronger pulsation	Valve ball on suction side Blocked	Ensure movability of valve ball
Product from muffler	Diaphragm cracked	Replace diaphragm
Air in product	Diaphragm cracked	Replace diaphragm
Pump does not work despite air supply	Muffler clogged Air inlet filter clogged Valve balls sticking to valve seat	Clean or renew Clean or renew Loosen, use PTFE balls Instead
Valve balls deformed	Chemical attack Mechanical attack	Change material Change material
PTFE diaphragm cracked a after short time	Large solids in product Compressed air opened with a shock	Install a filter Install a slow start valve
Insufficient suction head	Valve ball and seat leaking Pump completely dry	Replace Fill suction line
Pump very loud, crackling noise	Control valve worn Excessive feed on the suction side	Replace Install heavier valve balls Throttling of suction line
Air valve Piston hard moving	Compressed air too dry (Instrument air) Temperature too high Compressed air dirty Air valve piston damaged	Lubricate the air  Cool down Install a filter Replace
After filling the line pump stand still	Air pressure too low Too high viscosity Viscosity too high	Increase air pressure

## 6.0 Technical data

### 6.1 Dimensional drawings

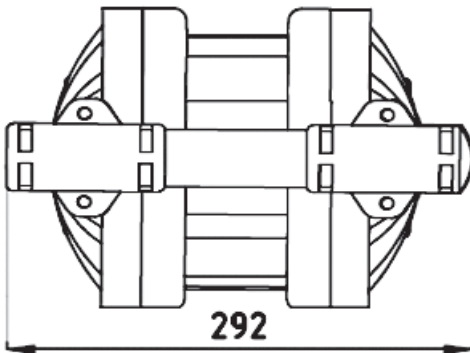
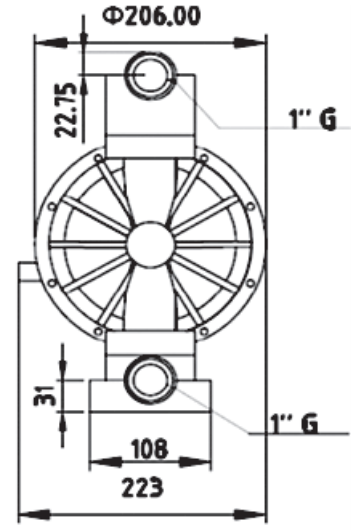
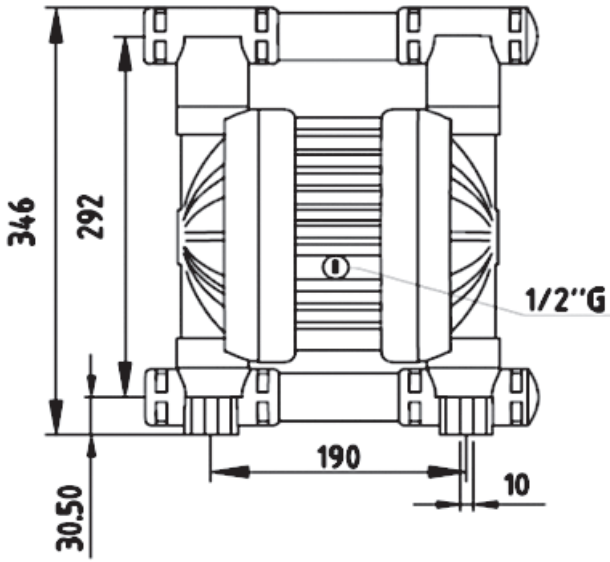

## 6.2 Performance

### Ruby 025 Non Metallic pump PTFE A Full capacity Diaphragm Fitted

Flow. Rate .....165 L/min  
 Air inlet .....1/2"  
 Suction – Discharge port .....1" BSP G  
 Suction lift (dry) .....4 m  
 Max. Solid size ( diameter) .....3.5 mm

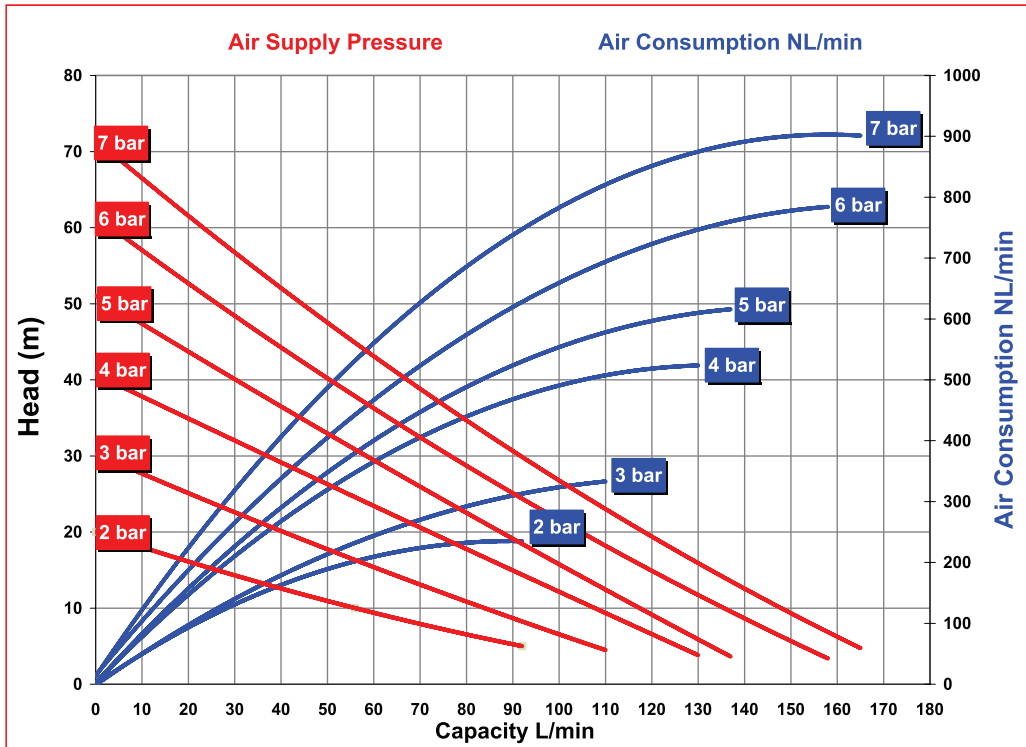

\* The curves and performance values refer to pumps with submerged suction and a free delivery outlet with water at 20°C, and vary according to the construction material.

**Ruby 025 Non Metallic pump  
Rubber Diaphragm Fitted**

Flow. Rate .....175 L/min  
 Air inlet .....1/2"  
 Suction – Discharge port .....1" BSP G  
 Suction lift (dry) .....4 m  
 Max. Solid size ( diameter) .....3.5 mm

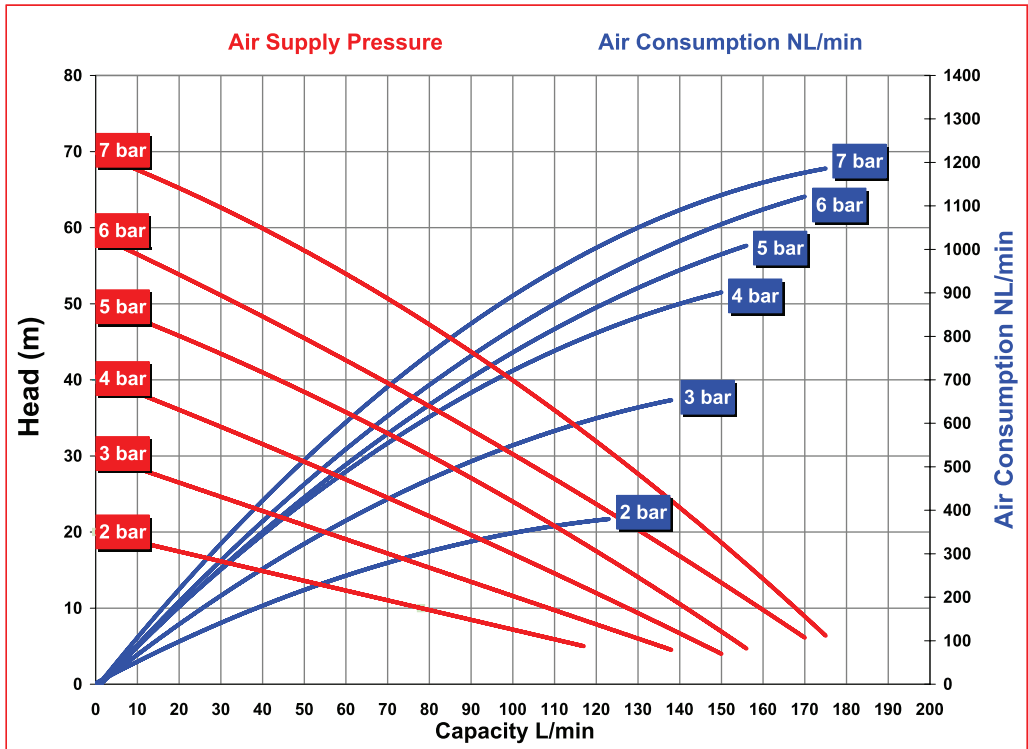

\* The curves and performance values refer to pumps with submerged suction and a free delivery outlet with water at 20°C, and vary according to the construction material.

**Ruby 025 Non Metallic pump  
PTFE Diaphragm Fitted**

Flow. Rate .....150 L/min  
 Air inlet .....1/2"  
 Suction – Discharge port .....1" BSP G  
 Suction lift (dry) .....4 m  
 Max. Solid size ( diameter) .....3.5 mm

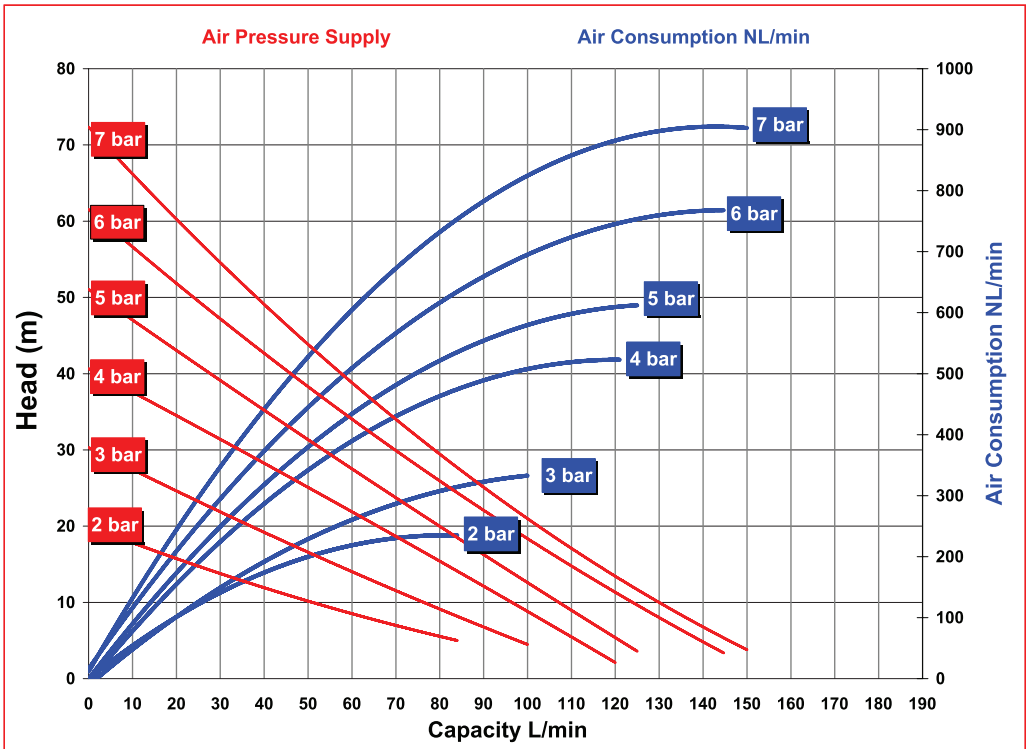

\* The curves and performance values refer to pumps with submerged suction and a free delivery outlet with water at 20°C, and vary according to the construction material.

## 6.3 Exploded View and Spare Parts List

### 6.3.1 Exploded view

#### Ruby 025 Non Metallic Pump



025 PP - PVDF spare part list pump

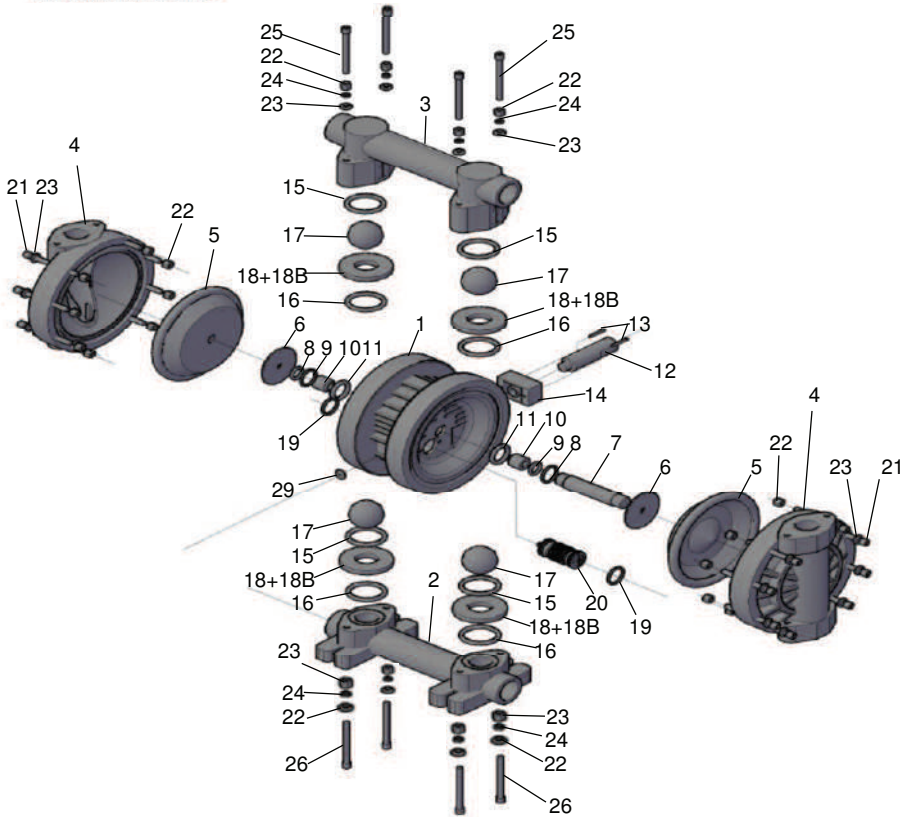

POS	DESCRIPTION	QTY
1	CENTRAL BLOCK	1
2	SUCTION MANIFOLD	1
3	DISCHARGE MANIFOLD	1
4	PUMP HOUSING	2
5	DIAPHRAGMS	2
6	PISTON INNER	2
7	SHAFT	1
8	RETAINING RING SHAFT	2
9	O-RING BEARING	2
10	SHAFT BEARING	2
11	O-RING BEARING	2
12	SILENCER	1
13	AIR EXHAUST SCREW	2
14	AIR EXHAUST COVER	1

POS	DESCRIPTION	QTY
15	VALVE SEAT ORING DOWN	4
16	VALVE SEAT ORING UP	4
17	VALVE BALL	4
18+18B	BALL SEAT + SEAT ORING	4+4
19	RETAINING RING AIR VALVE	2
20	AIR CONTROL VALVE	1
21	HOUSING PUMP SCREW	16
22	BOLT	24
23	WASHER	20
24	WASHER	8
25	DISCHARGE MANIFOLD SCREW	4
26	SUCTION MANIFOLD SCREW	4
29	DRIVE AIR INLET	1

### 6.3.2 Spare Part list

#### Ruby 025 Spares PP / PVDF / PP+CF / PVDF+CF



POSITION	Part No	DESCRIPTION	No req.
25.01	R025-0252	CENTRAL BLOCK 025 PP	1
25.01	R025-0253	CENTRAL BLOCK 025 PP+CF	1
25.02	R025-0262	SUCTION MANIFOLD PP 025	1
25.02	R025-0263	SUCTION MANIFOLD PVDF+CF 025	1
25.02	R025-0264	SUCTION MANIFOLD PP+CF 025	1
25.03	R025-0272	DISCHARGE MANIFOLD PP 025	1
25.03	R025-0273	DISCHARGE MANIFOLD PVDF+CF 025	1
25.03	R025-0274	DISCHARGE MANIFOLD PP+CF 025	1
25.04	R025-0282	PUMP HOUSING PP 025	2
25.04	R025-0283	PUMP HOUSING PVDF 025	2
25.04	R025-0284	PUMP HOUSING PP+CF 025	2
25.05	R025-0101	DIAPHRAGMS EPDM CONDUCTIVE	2
25.05	R025-0102	DIAPHRAGMS TFM+ EPDM (COMPOUND)	2
25.05	R025-0102A	DIAPHRAGMS FULL CAPACITY TFM+ EPDM (COMPOUND)	2
25.05	R025-0103	DIAPHRAGMS NBR CONDUCTIVE	2
25.05	R025-0104	DIAPHRAGMS VITON CONDUCTIVE	2
25.06	R025-0134	PISTON INNER 025	2
25.07	R025-0136	SHAFT	1
25.08	R025-0210	RETAINING RING 1.4122 SHAFT	2
25.09	R025-0181	O-RING BEARING 025	2
25.10	R025-0131	SHAFT BEARING 025	2
25.11	R025-0182	O-RING BEARING 025	2
25.12	R025-0140	SILANCER 025	1
25.13	R025-0185	AIR EXHAUST SCREW	2
25.14	R025-0141	AIR EXHAUST COVER PP	1
25.14	R025-0141B	AIR EXHAUST COVER PP+CF	1
25.15	R025-0171	VALVE SEAT ORING DOWN 025 PTFE	4
25.15	R025-0171E	VALVE SEAT ORING DOWN 025 EPDM	4
25.15	R025-0171F	VALVE SEAT ORING DOWN 025 FKM	4
25.15	R025-0171N	VALVE SEAT ORING DOWN 025 NBR	4
25.16	R025-0175	VALVE SEAT ORING UP 025 PTFE	4
25.16	R025-0175E	VALVE SEAT ORING UP 025 EPDM	4
25.16	R025-0175F	VALVE SEAT ORING UP 025 FKM	4
25.16	R025-0175N	VALVE SEAT ORING UP 025 NBR	4
25.17	R025-0121	VALVE BALL EPDM 025	4
25.17	R025-0122	VALVE BALL PTFE 025	4
25.17	R025-0123	VALVE BALL NBR 025	4
25.17	R025-0124	VALVE BALL AISI316 025	4
25.18	R025-0111	BALL SEAT EPDM 025	4
25.18	R025-0117	BALL SEAT PVDF NEW SERIES ( WITH INSIDE ORING)	4
25.18	R025-0116	BALL SEAT PP NEW SERIES ( WITH INSIDE ORING)	4
25.18	R025-0116A	BALL SEAT PP (OLD SERIES)	4
25.18	R025-0113	BALL SEAT NBR 025	4
25.18	R025-0114	BALL SEAT AISI316 025	4
25.18B	R025-0176F	VALVE SEAT INSIDE ORING 025 FKM	4
25.18B	R025-0176E	VALVE SEAT INSIDE ORING 025 EPDM	4
25.18B	R025-0176N	VALVE SEAT INSIDE ORING 025 NBR	4
25.18B	R025-0176T	VALVE SEAT INSIDE ORING 025 PTFE	4
25.19	R025-0211	RETAINING RING 1.4122 AIR VALVE	2
25.20	R025-0139	AIR CONTROL UNIT 015/R025/040	1
25.21	R025-0195	HOUSING SCREWS (PLASTIC MOD)	16
25.22	R025-0197A	BOLT	24

POSITION	Part No	DESCRIPTION	No req.
25.23	R025-0198A	WASHER A2 DIN 125 A2-M6	20
25.24	R025-0199	WASHER A2 DIN 9021 6,4	8
25.25	R025-0194	DISCHARGE MANIFOLD SCREWS	4
25.26	R025-0196	SUCTION MANIFOLD SCREWS (PLASTIC MOD)	4
25.29	R025-0146	AIR CONNECTION	1





# ALPHADYNAMIC PUMPS

Industrial Park of Kifisia - HELLAS

Air Operated Diaphragm Pumps

[www.alphadynamic.eu](http://www.alphadynamic.eu)

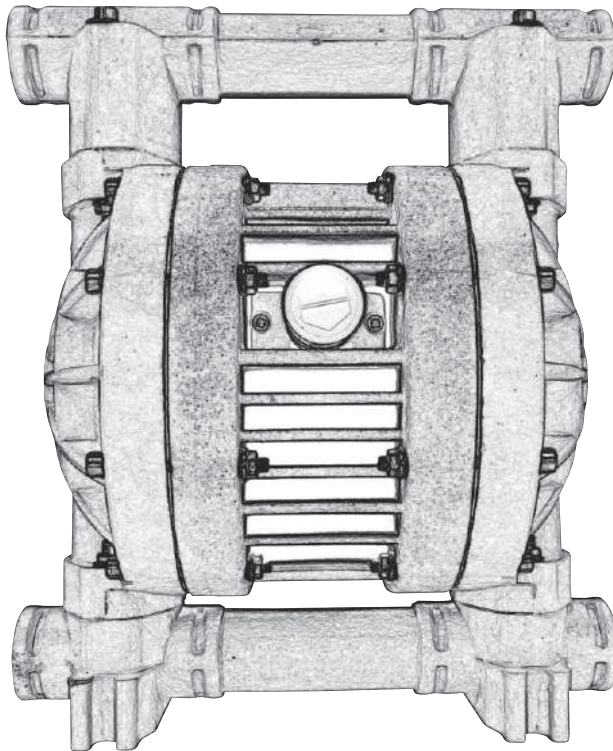

VER 3.2021



*We Make The Difference*