

We Make The Difference

MDROO SERIES MX/MN

Horizontal single-stage
centrifugal pump

50Hz

hydroo®





PRESENTATION

Hydroo Pump Industries SL is an enterprise specialised in the research, development and large-scale production of Stainless Steel centrifugal pumps. We have a vertical integration of the production processes, standing out stamping, welding and motor wiring in 6 value centers and production units. All of them with a high performance management on pump engineering and production quality.

HYDROO has set up a wide range of pumping solutions for many applications as building services, industry, irrigation and industrial process. Customers enjoy of the highest performance in booster sets and pressurization, fire-fighting sets, pumping of underground water, HVAC, drainage and sewage, utilities, desalination and OEM integrations. Versions in 50 Hz and 60 Hz are available, as well as any modification on materials, on request.

Global water challenges require excellence in pumping technologies

and close cooperation between pump designers, manufacturers and pump engineers. In order to better meet the customers' needs and requirements our company is facing an expansion of its operations worldwide, providing timely and effective services in more than 30 countries. With tight relationships in many regions, we're proud to introduce a new regional value center for Europe. We are based near Barcelona at the Girona industrial area. Hydroo is a trademark to forge excellent and successful business relationships with our value customers by means of an operative assembling unit and an application engineering unit. HYDROO trademark wants to symbolize the firm commitment for a high level service to our value partners.

At Hydroo we bet on a high level service to our value pump partners.

MX/MN

Stainless steel
horizontal
single-stage
centrifugal pump

Applications

Water treatment systems
Water supply for family
houses, for small hotel
and small office buildings
Family gardening irrigation
systems
Other pressure boosting
systems



Description

Light horizontal single-stage centrifugal pumps made in AISI304 SS, with threaded inlet and outlet for easy installation and service. Standard totally enclosed, fan cooled, insulation class F, IP 55 motors. Single phase motors up to 2,2 kW.

Standard versions are suitable for smart pumping of clean water with a temperature range between -10°C and 85°C.

Performance range

Flow rate: 1.2 ~ 26 m³/h

Head: 10 ~ 40 m

Temperature: -10°C ~ +85 °C

Speed: n 2900 rpm or 3500 rpm

Power: P up to 2,2 kW

Standard material

Stainless steel. AISI304.

AISI316 available on request.

Performance scope

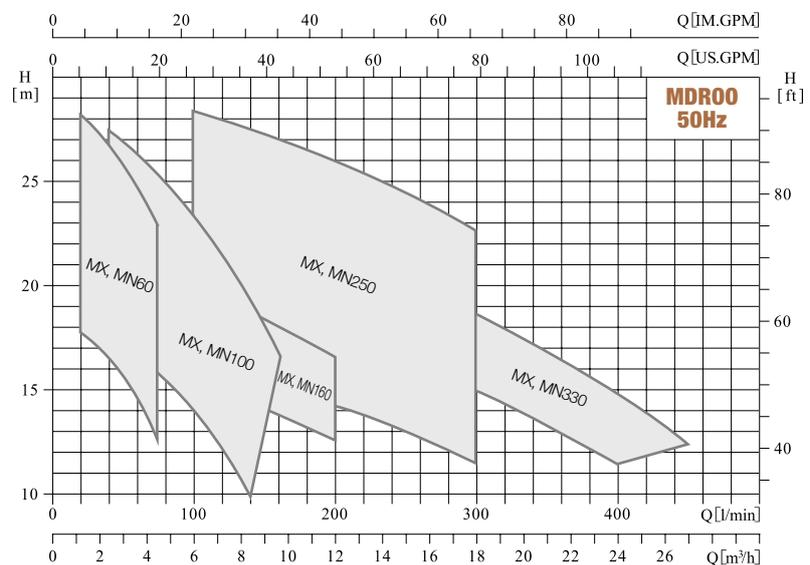

Definition of model

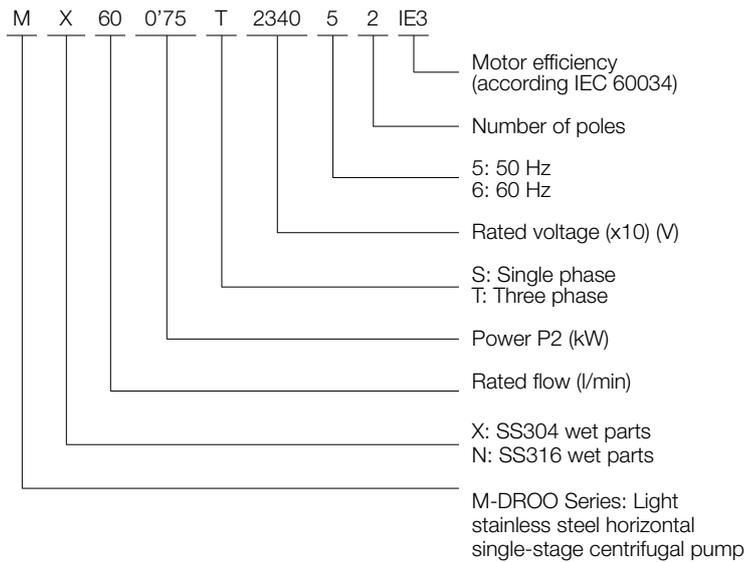

Structure features

- MX/MN series of single-stage centrifugal pump with axial suction and radial discharge features.
- Compact structure, the pump is directly connected with the motor, coaxial installation.
- Convenient installation, screw thread water inlet and outlet.
- Light weight, thin plate pressing structure for main parts and components.
- A little corrosion resistance, material of wet parts is AISI 304 or AISI 316 stainless steel.

Application

- Pressurization and pumping of industrial and civilian clean water or other liquids.
- Water treatment.
- Water circulating system.
- Agricultural irrigation.
- Other fields.

Pumping liquids

- Thin, clean, non-flammable and explosive, not containing the liquid with solid particle and fiber.
- Able to transmit light corrosive medium (Relate to the content of chloride ion in the medium, concentration of acid and alkali, whether generate corrosion on the rubber and mechanical seal materials).
- The density of transmitted medium is less than that of clean water, viscosity is close to water. Otherwise the motor of large power is required.

Operating condition

- Liquid temperature: -10°C ~ +85°C.
- Ambient temperature: up to +40°C.
- Altitude: up to 1000m.
- Max. Pressure of the system is 8 bar.

Motor

- TEFC motor, 2-pole.
- Protection class: IP 55.
- Insulation class: F.
- Standard voltage:
1 x 220 V
3 x 380V/3 x 220V

Installation requirements

- The pump shall be fastened on the stable horizontal base.
- The installation of the pump shall ensure that the pump will not be influenced by the tension of the pipeline.
- The pump shall be installed on the ventilation and anti-freezing place to ensure normal operation of the motor.
- Electric wiring device shall guarantee that the pump will not be damaged by lack of phase, unstable voltage, current leakage and overload.

Curves

- Include performance curve in the technical data:
- All curves are based on the measured values of 50Hz: constant motor speed 2850r/min.
 - Measurement is done with 20°C air-free water, kinematic viscosity of 1mm²/sec.
 - Curve tolerance in conformity with ISO9906 Annex A.
 - The operation of pump shall refer to the performance region to prevent overload of motor due to too large flow rate.

Performance table

Model	Driving motor		Q (l/min)	20	40	60	80	100	120	140	160	200	250	300	330	350	400	450	
	(kW)	(hp)		Q (m ³ /h)	1,2	2,4	3,6	4,8	6	7,2	8,4	9,6	12	15	18	20	21	24	27
			H (m)																
MX, MN 60/0,37	0,37	0,5		17,7	16,4	14,6	11,4												
MX, MN 60/0,55	0,55	0,75		22,7	21,3	19,5	16,2												
MX, MN 60/0,75	0,75	1		28,2	26,8	25	22												
MX, MN 100/0,55	0,55	0,75			17,8	16,7	15,4	14	12,2	9,9									
MX, MN 100/1,1	1,1	1,5			27,4	26,3	25	23,4	21,5	19,5	16,7								
MX, MN160/0,75	0,75	1				15,5	15,3	15	14,8	14,3	13,8	12,5							
MX, MN 160/1,1	1,1	1,5				19,7	19,5	19,3	19,1	18,7	18,2	16,5							
MX, MN 250/1,1	1,1	1,5						15,8	15,6	15,4	15	14,3	13	11,5					
MX, MN 250/1,5	1,5	2						23,2	23	22,7	22,2	21,4	19,8	17,7					
MX, MN 250/2,2	2,2	3						28,2	27,8	27,5	27	26,2	24,6	22,6					
MX, MN 330/1,5	1,5	2							18,8	18,7	18,5	17,8	16,7	15	14	13,5	11,6		
MX, MN 330/2,2	2,2	3							22,5	22,2	22	21,5	20,3	18,7	17,5	16,8	14,8	12,3	

Section drawing

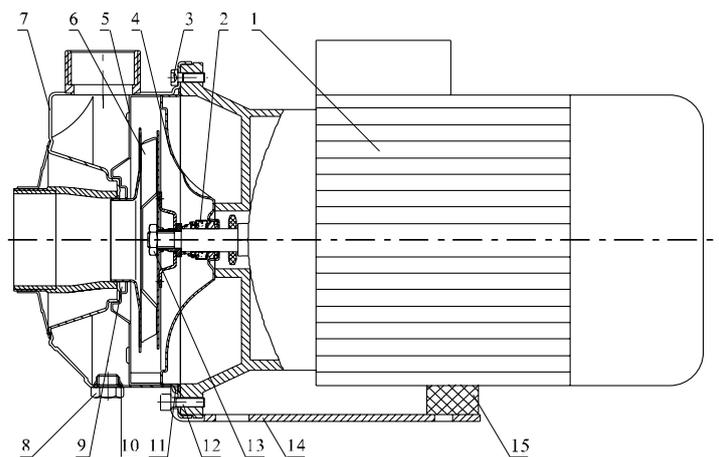

Material

N°	Parts	Material	AISI/ASTM
1	Motor		
2	Mechanical seal	Carbon/Silicon Carbide	
3	M6x15/Screw	0Cr18Ni9/SS304	AISI304
4	Seal base	0Cr18Ni9/SS304	AISI304
5	Diffuser	0Cr18Ni9/SS304	AISI304
6	Impeller	0Cr18Ni9/SS304	AISI304
7	Pump body	0Cr18Ni9/SS304	AISI304
8	Vent	0Cr18Ni9/SS304	AISI304
9	O-ring	NBR	
10	O-ring	NBR	
11	O-ring	NBR	
12	M6x15/Screw	0Cr18Ni9/SS304	AISI304
13	Nut M10	0Cr18Ni9/SS304	AISI304
14	Base	Steel	A570
15	Support foot	NBR	

MX, MN 60

Performance curve
ISO9906 Annex A

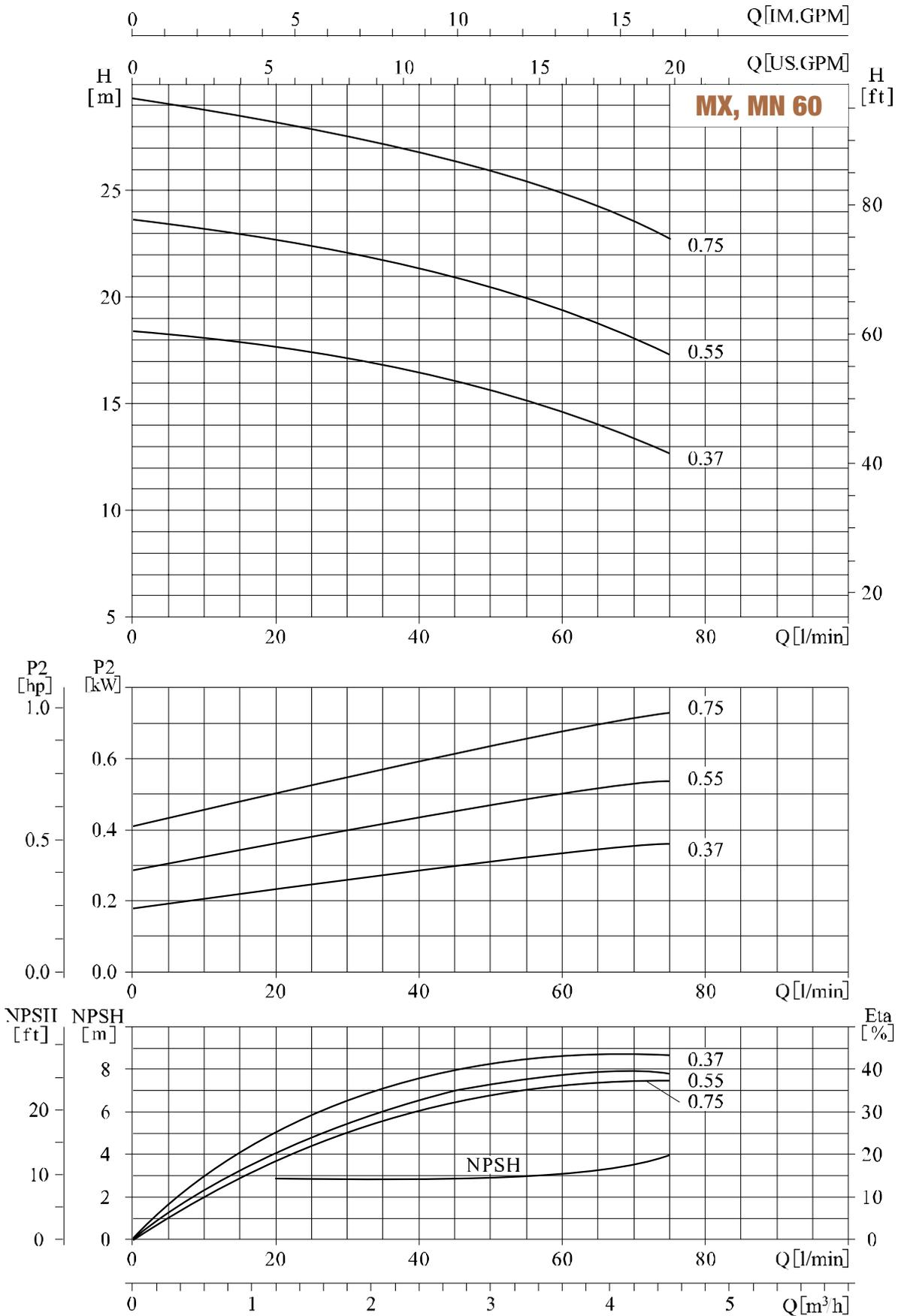

MX, MN 100

Performance curve
ISO9906 Annex A

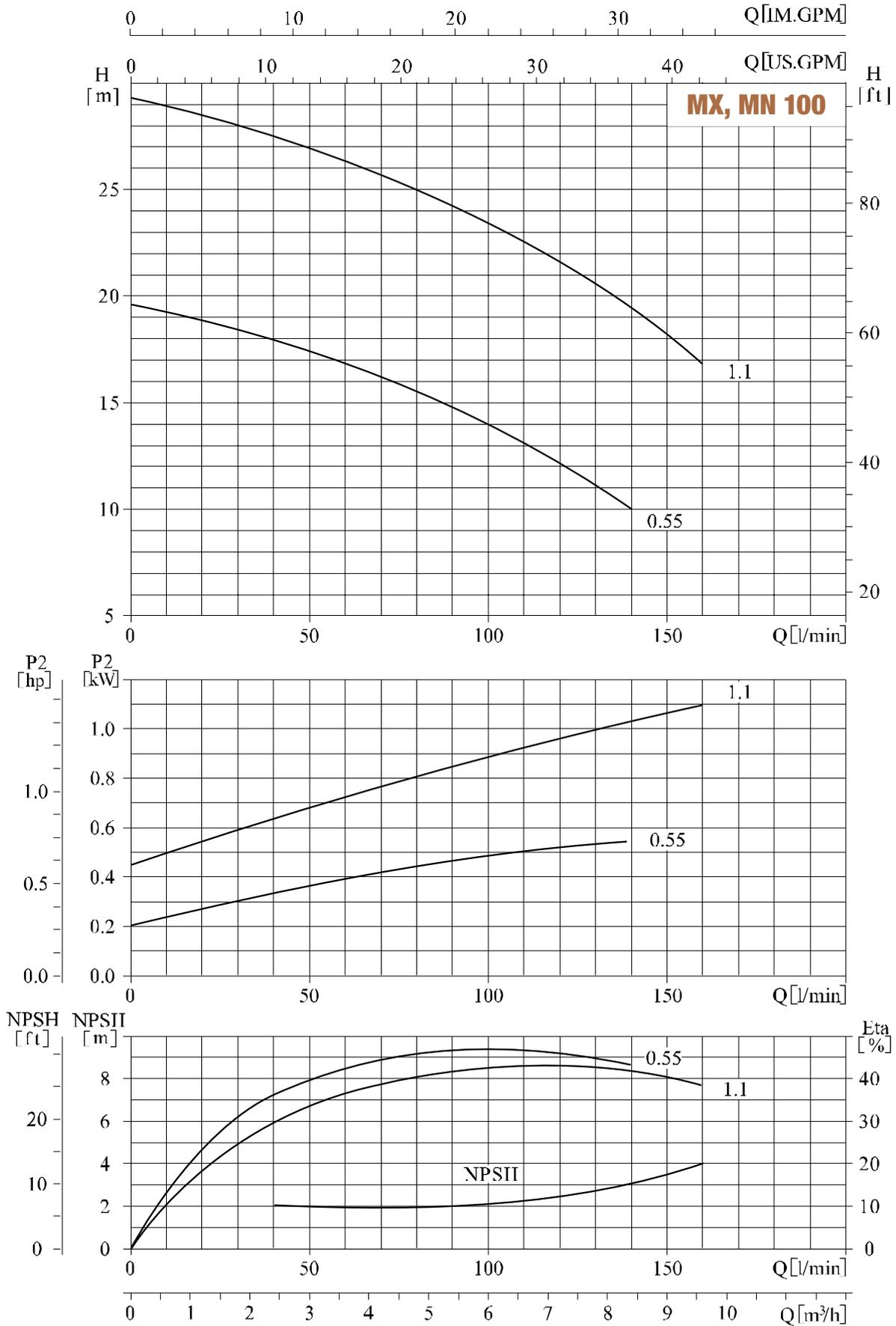

MX, MN160

Performance curve
ISO9906 Annex A

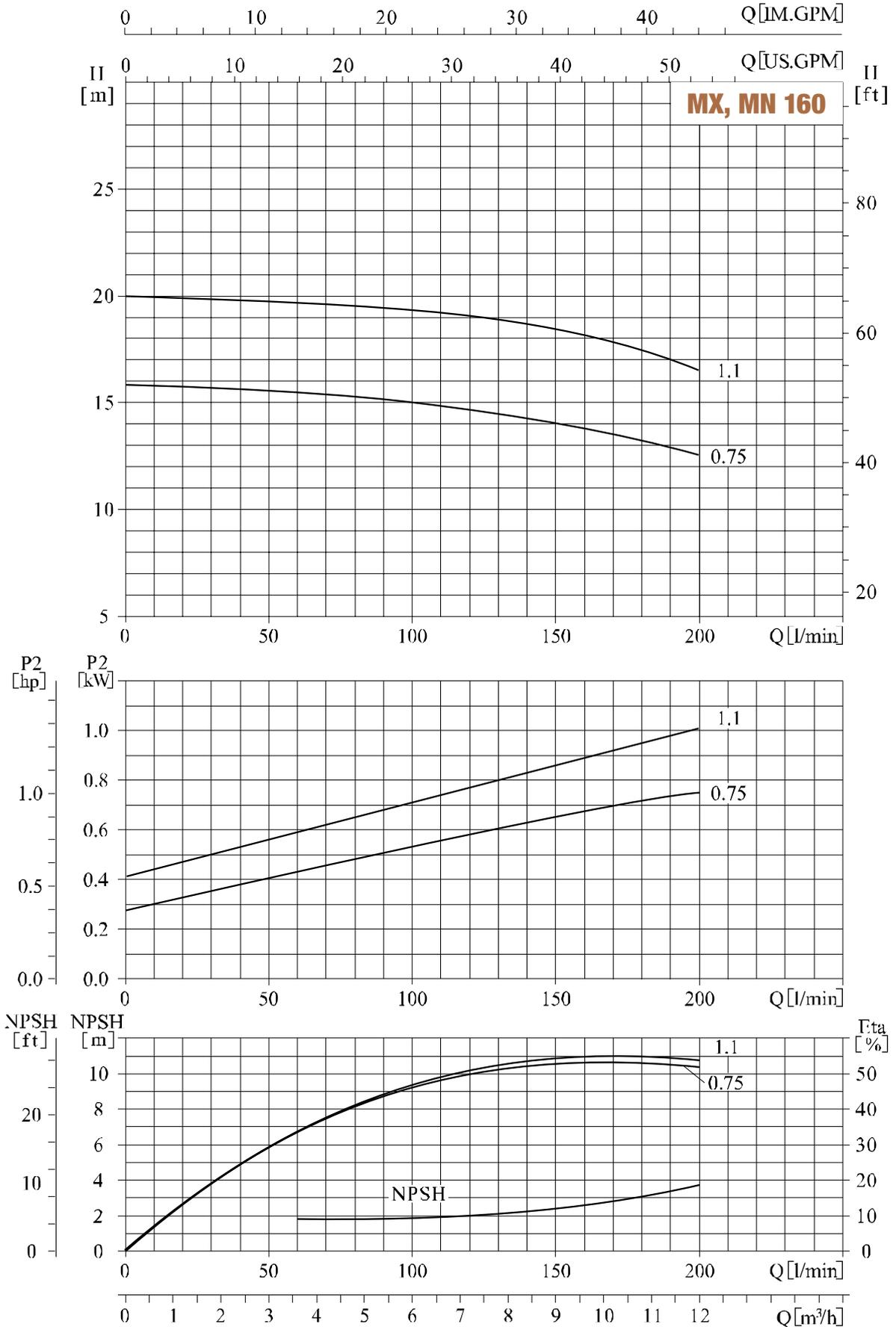

MX, MN 250

Performance curve
ISO9906 Annex A

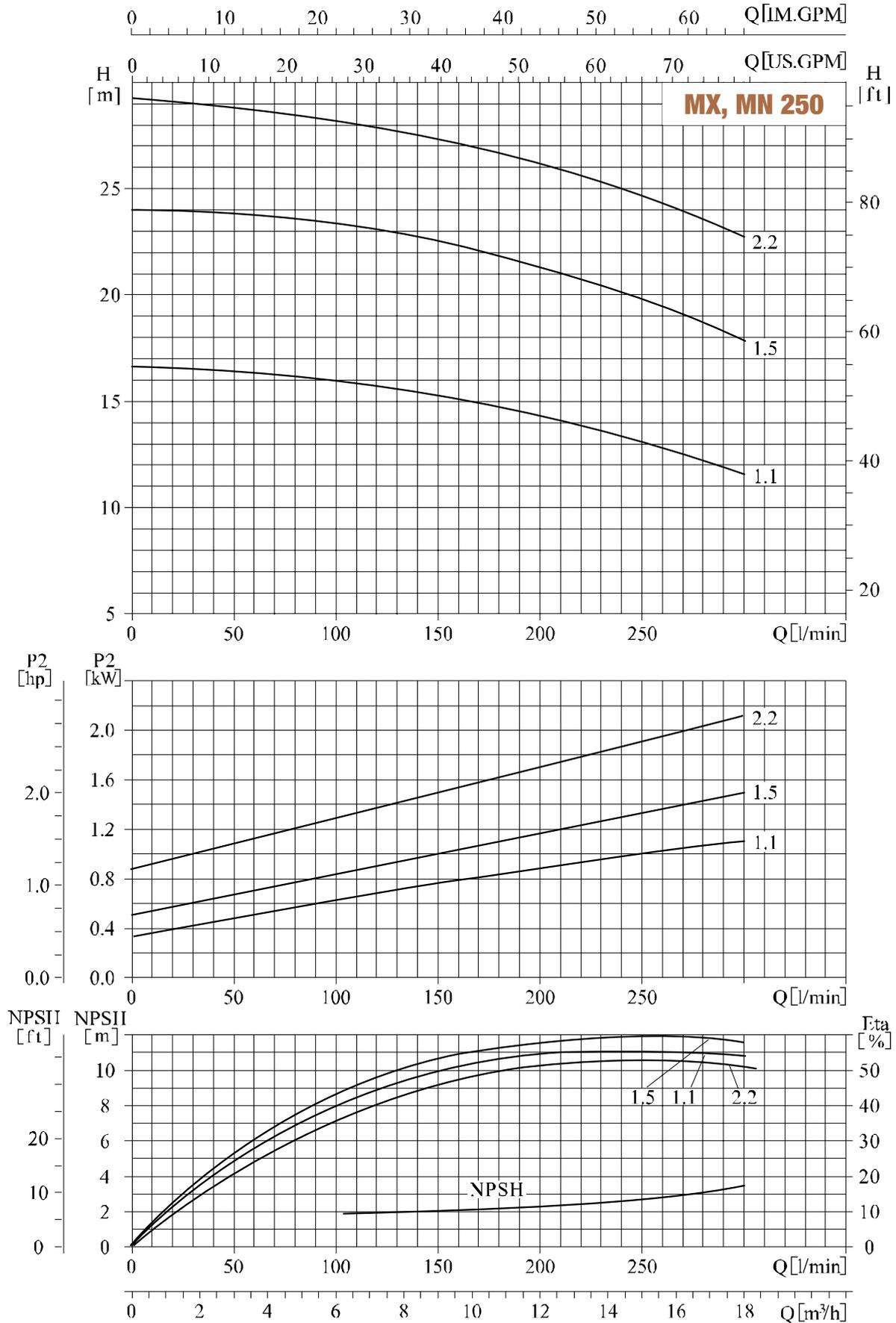

MX, MN 330

Performance curve
ISO9906 Annex A

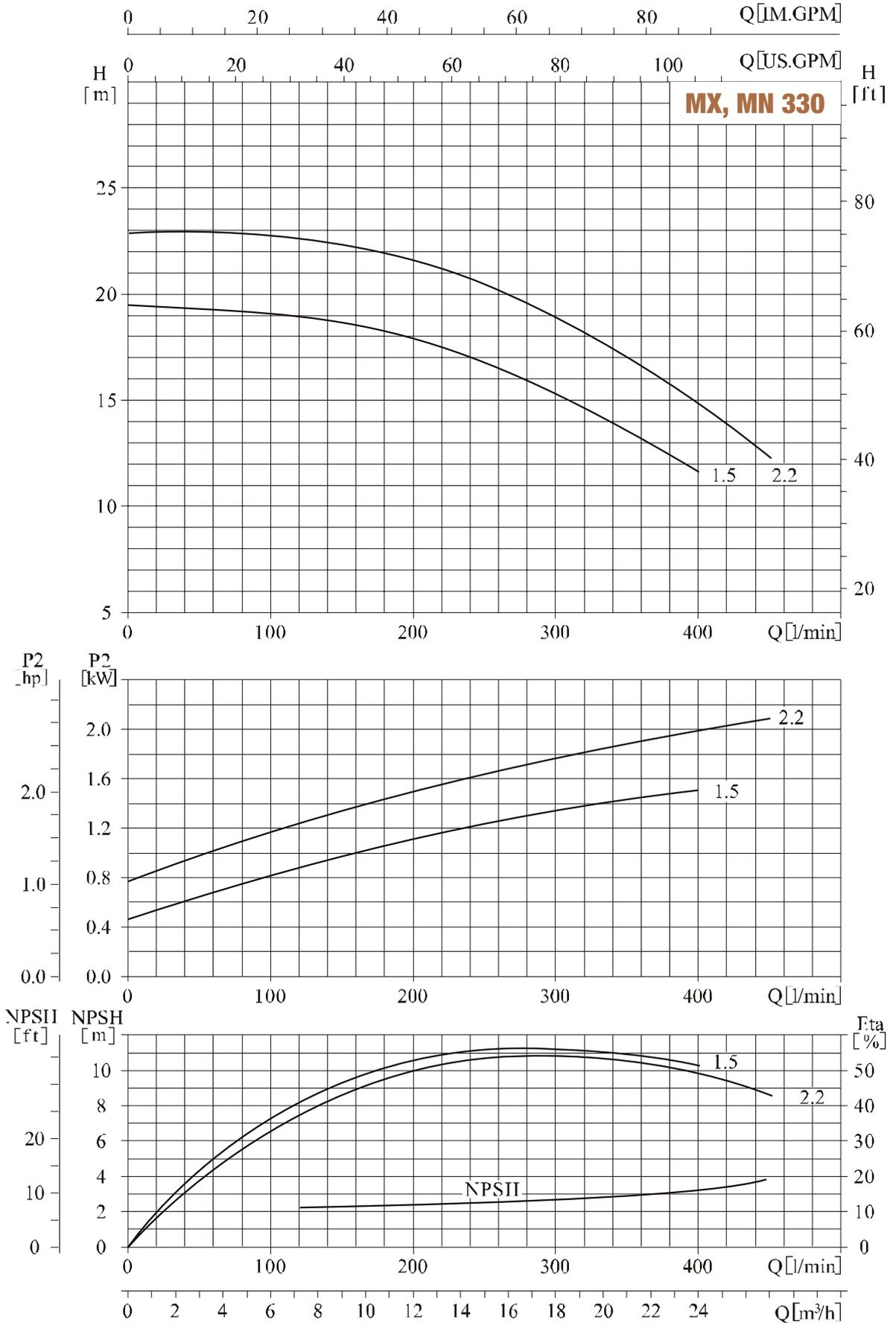

Installation sketch

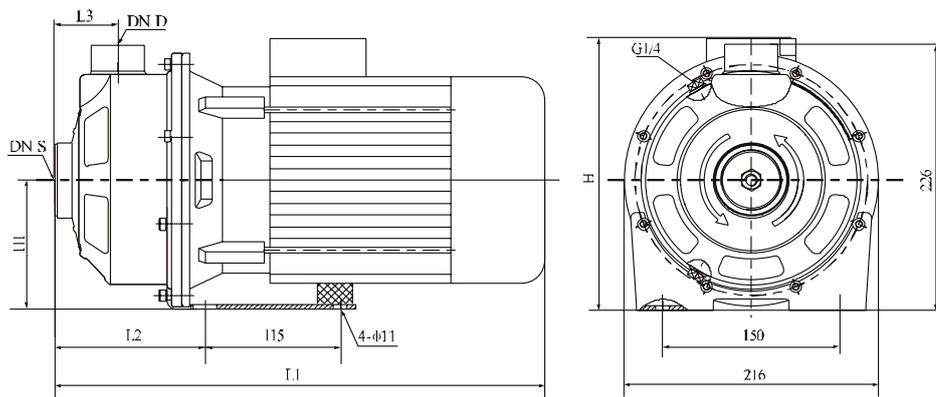

Size and weight

Model	motor			L1	L2	L3	H	DN S	DN D	Weight
	Phase	(KW)	(hp)	(mm)				Inlet	Outlet	kg
MX, MN 60/0,37	3PH 1PH	0,37	0,5	328	113	51	216/230	G1-1/4	G1	10
MX, MN 60/0,55		0,55	0,75	328	113	51	216/230	G1-1/4	G1	12
MX, MN 60/0,75		0,75	1	361	113	51	223/245	G1-1/4	G1	14
MX, MN 100/0,55		0,55	0,75	328	113	51	216/230	G1-1/4	G1	12
MX, MN 100/1,1		1,1	1,5	361	113	51	223/245	G1-1/4	G1	16
MX, MN 160/0,75		0,75	1	375	127	54	223/245	G1-1/2	G1-1/4	14
MX, MN 160/1,1		1,1	1,5	375	127	54	223/245	G1-1/2	G1-1/4	16
MX, MN 250/1,1		1,1	1,5	375	127	54	223/245	G1-1/2	G1-1/4	16
MX, MN 250/1,5		1,5	2	415	127	54	232/253	G1-1/2	G1-1/4	20
MX, MN 250/2,2		2,2	3	415	127	54	232/253	G1-1/2	G1-1/4	23
MX, MN 330/1,5		1,5	2	415	127	54	232/253	G2	G1-1/4	20
MX, MN 330/2,2		2,2	3	415	127	54	232/253	G2	G1-1/4	23

BE
PUMPING
PARTNERS

www.alphadynamic.eu

AlphaDynamic Pumps SA

Production Plant - Greece
Inofita Industrial area
59th km Nat.Road Athens - Lamia
GR 320 11 Inofita Viotia, Greece

Tel +30 215 215 9520 , +30 215 215 9580
Email: Sales@alphadynamic.eu

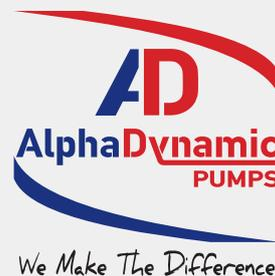

hydroo[®]