



We Make The Difference

NDROO SERIES NL, N

Single Stage
End Suction Pump

hydroo[®]





PRESENTATION

HYDROO has set up a worldwide distribution network with key partners and is providing value to pump engineers and end users. We have an extensive pump portfolio with high-end solutions for many applications, including water-supply booster sets, fire-fighting equipment, borehole, HVAC, drainage and sewage, utilities, irrigation, desalination and RO equipment, and OEM integration, among many others. We provide solutions for all markets for 50 Hz and 60 Hz, including customized versions.

HYDROO has a factory in Palol de Revardit (Catalonia- Spain). It's been sized to guarantee our reliable, long-term, personalized manner and offer the best service to all our customers. We provide a wide range of products in an extremely short delivery time, thanks to our Lean manufacturing processes and our qualified professional and enthusiastic team.

Our commitment to ethics and legislation in relation to third parties is compiled in a public document of principles. The document has been agreed upon by the entire Hydroo team and its implementation is being coordinated by a committee to ensure the compliance and strengthening of the corporate culture in the whole company.

The expansion of Hydroo is based on excellence in operations and a successful business relationship with partners. Therefore, we face a strong growth in the target market. We are fully audited by SGS for ISO9001 and ISO14000 standards annually.

At HYDROO, we are committed to providing excellent service to our valued pump partners.

NL N

Single stage
end suction
centrifugal pump

Applications

Cooling water
Water supply/distribution
Drainage
Irrigation
General industrial services



Performance scope

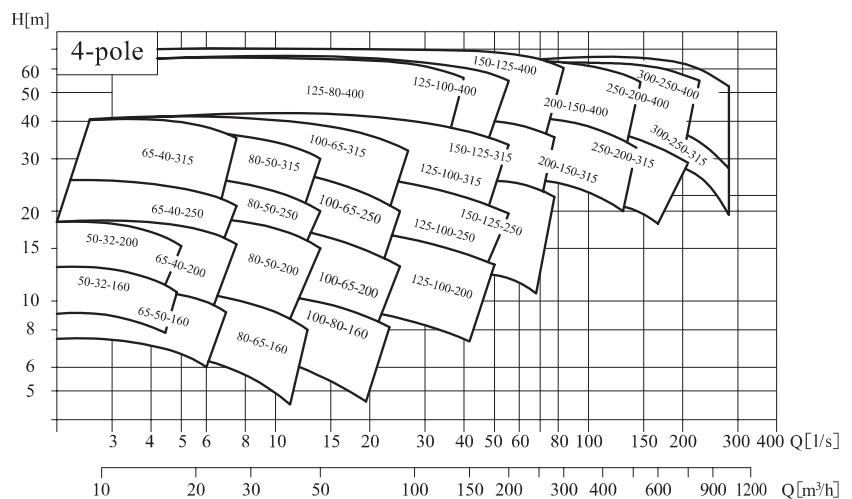
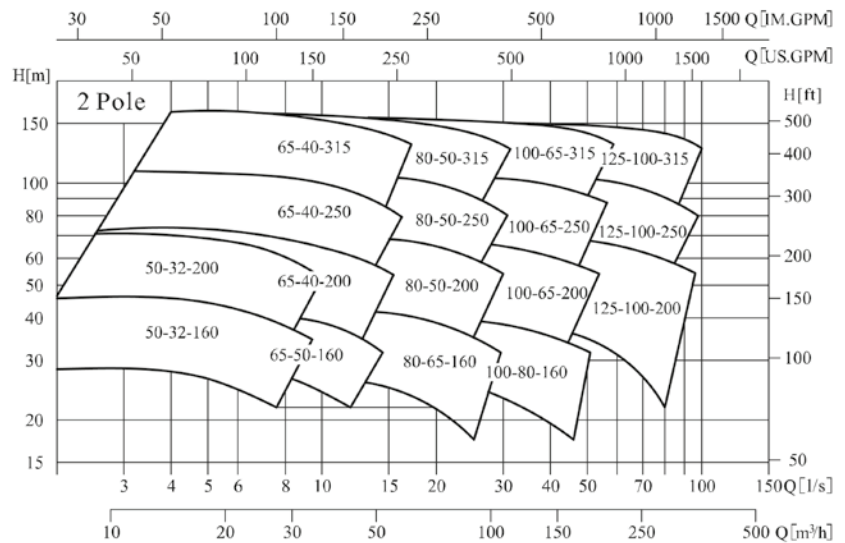

Description

Back pull out design for fast and easy maintenance.

Performance range

Capacity: Q up to 1000 m³/h

Head: H up to 160 m

Temperature: T up to 110 °C

Speed: n 2900/1450 rpm

Power: P up to 160 kW

Standard material

Casing: Cast iron

Impeller: Cast iron or bronze

Shaft: Stainless steel

Definition of model

NLFX 100-65-200/30 T4069-5-2-IE3

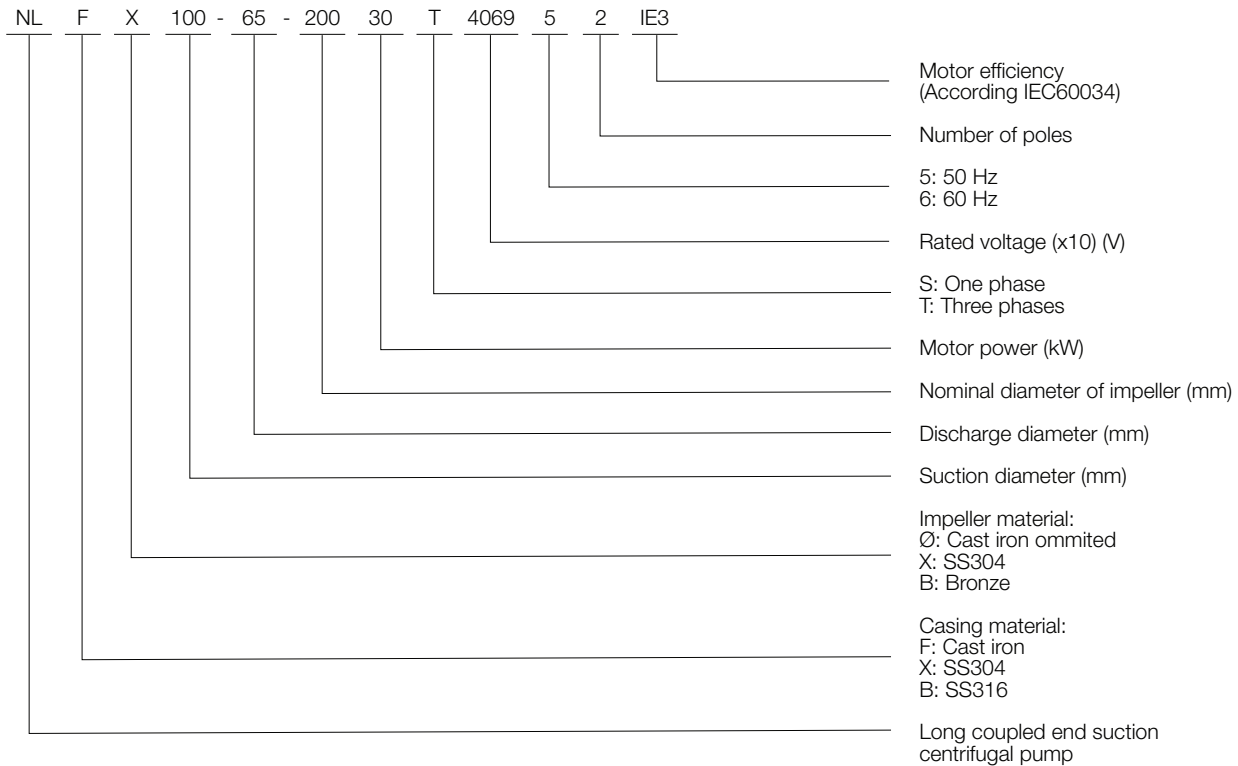

Min inlet pressure

- Min inlet pressure depends on $NPSH + 0.5m$ safety margin + gasified pressure. It should be re-calculated the inlet pressure of one of the following happens.
- The liquid is more warm.
- The flow exceeds the nominate value.
- Suction distance is very long or inlet pipe is very long.
- System pressure is too little.
- Inlet pressure is low, working pressure is low.

Typical application

- Clean, thin, non-corrosive, non-flammable or non-explosive liquid without grain or fiber.
- Water supply system
- Heat, air condition system
- Booster, constant pressure water supply
- Firefighting, splitting system
- Irrigating, farming
- Industry cooling, heater circulation system
- Industry transferring, drainage system

Construction

- Non-self-priming, single stage, single suction, horizontal, axial suction and radical discharge, pump body is fixed by base.
- NLF Pump use bearing cradle, which can orientate bearing, prevent from radical vibration, improve the rigidity of rotary part.
- NLF Pump use compacted shaft, use deep groove grease lubricated roller bearing.
- NLF Pump use connect pump and motor with semi-flexible coupling.
- Use standard wearable mechanical seal.
- TEFC motor, size complies to IEC standard.
- NLF Pump dimensions is conform to ISO 2858.
- NF, NX Pump are stub shaft.

Specification

- Flow: Max $800m^3/h$
- Head: Max 160m
- Working pressure: Max 16 bar
- Inlet pressure: Max 6 bar
- Power: Max 160kW
- Liquid temperature: $-15\text{ }^\circ\text{C} \sim 110\text{ }^\circ\text{C}$
- Inlet and Outlet diameter:
 - Inlet diameter: DN50~DN250
 - Outlet diameter: DN32 ~DN200

Curve conditions

- Curves tolerance is according to ISO9906, Annex A;
- All curves are based on the measured value of constant motor speed 2900 rpm, 2950rpm, 1450rpm or 1480rpm.
- The measurements were made with aireless water at temperature of $20\text{ }^\circ\text{C}$. The curves apply to a kinematic viscosity of $1mm^2/s$ (1 cst)

Features

- Back-pull-out design, no need to disturb pump body and pipelines when servicing.
- All the NLF Pump models only use 4 kinds of pumps shafts and bearing cover, make parts exchangeable.
- Impeller is optimum design, inlet is enlarged, no whirlpool, deduct the water pump NPSH efficiently, wich makes pump work stable with little noise.
- NF, NX Pump are small, compact, easy to install.

Models 2 Pole

N°	Model	Q(m ³ /h)	H(m)	Motor (kW)	n(r/min)	
1	NLF 50-32-160/3	12,5	28	3	2900	
2	NLF 50-32-160/4		36	4		
3	NLF 50-32-160/5,5		44	5,5		
4	NLF 50-32-200/7,5		55	7,5		
5	NLF 50-32-200/11		74	11	2950	
6	NLF 65-40-200/7,5	25	48	7,5	2900	
7	NLF 65-40-200/11		62	11	2950	
8	NLF 65-40-200/15		72	7,5		
9	NLF 65-40-250/18,5		84	11		
10	NLF 65-40-250/22		95	15		
11	NLF 65-40-250/30		105	18,5		
12	NLF 65-40-315/22		105	22		
13	NLF 65-40-315/30		120	30		
14	NLF 65-40-315/37		145	37		
15	NLF 65-40-315/45		165	45		
16	NLF 65-50-160/4		28	4		2900
17	NLF 65-50-160/5,5		36	5,5		
18	NLF 65-50-160/7,5		42	7,5		
19	NLF 80-50-200/11		50	44	11	2950
20	NLF 80-50-200/15			57	15	
21	NLF 80-50-200/18,5	64		18,5		
22	NLF 80-50-200/22	71		22		
23	NLF 80-50-250/30	84		30		
24	NLF 80-50-250/37	100		37		
25	NLF 80-50-315/37	105		37		
26	NLF 80-50-315/45	125		45		
27	NLF 80-50-315/55	140		55		
28	NLF 80-50-315/75	152		75		
29	NLF 80-65-160/5,5	22		5,5	2900	
30	NLF 80-65-160/7,5	29		7,5		
31	NLF 80-65-160/11	38		11	2950	
32	NLF 80-65-160/15	44		15		
33	NLF 100-65-200/18,5	100		36	18,5	2950
34	NLF 100-65-200/22		43	22		
35	NLF 100-65-200/30		56	30		
36	NLF 100-65-200/37		67	37		
37	NLF 100-65-250/45		80	45		
38	NLF 100-65-250/55		88	55		
39	NLF 100-65-250/75		108	75		
40	NLF 100-65-315/90		128	90		
41	NLF 100-65-315/110		148	110		
42	NLF 100-80-160/11		23	11		
43	NLF 100-80-160/15		30	15		
44	NLF 100-80-160/18,5		35	18,5		
45	NLF 100-80-160/22		40	22		
46	NLF 125-100-200/30		200	34	30	
47	NLF 125-100-200/37			41	37	
48	NLF 125-100-200/45	48		45		
49	NLF 125-100-200/55	55		55		
50	NLF 125-100-200/75	66		75		
51	NLF 125-100-250/75	75		75		
52	NLF 125-100-250/90	86		90		
53	NLF 125-100-250/110	100		110		
54	NLF 125-100-315/90	93		90		
55	NLF 125-100-315/110	108		110		
56	NLF 125-100-315/132	124		132		
57	NLF 125-100-315/160	144		160		

Models 4 Pole

N°	Model	Q(m³/h)	H(m)	Motor (kW)	n(r/min)	
1	NLF 50-32-160/0,55	6,3	8,5	0,55	1450	
2	NLF 50-32-160/0,75		11	0,75		
3	NLF 50-32-200/1,1		14	1,1		
4	NLF 50-32-200/1,5		18	1,5		
5	NLF 65-40-200/1,1	12,5	12	1,1		
6	NLF 65-40-200/1,5		15	1,5		
7	NLF 65-40-200/2,2		17,5	2,2		
8	NLF 65-40-250/3		25	3		
9	NLF 65-40-315/4		34	4		
10	NLF 65-40-315/5,5		40	5,5		
11	NLF 65-50-160/0,55		7	0,55		
12	NLF 65-50-160/0,75		9	0,75		
13	NLF 65-50-160/1,1		10,5	1,1		
14	NLF 80-50-200/1,5		25	11	1,5	
15	NLF 80-50-200/2,2	15		2,2		
16	NLF 80-50-200/3	17,5		3		
17	NLF 80-50-250/4	21		4		
18	NLF 80-50-250/5,5	25		5,5		
19	NLF 80-50-315/5,5	30		5,5		
20	NLF 80-50-315/7,5	37		7,5		
21	NLF 80-65-160/0,75	6		0,75		
22	NLF 80-65-160/1,1	8		1,1		
23	NLF 80-65-160/1,5	10,5		1,5		
24	NLF 80-65-200/3	50	11,5	3		
25	NLF 100-65-200/4		14	4		
26	NLF 100-65-200/5,5		16	5,5		
27	NLF 100-65-250/5,5		20	5,5		
28	NLF 100-65-250/7,5		25	7,5		
29	NLF 100-65-315/11		32	11	1480	
30	NLF 100-65-315/15		40	15		
31	NLF 100-80-160/1,5		6,5	1,5	1450	
32	NLF 100-80-160/2,2		9	2,2		
33	NLF 100-80-160/3		10,5	3		
34	NLF 125-80-400/15	50	39	15	1480	
35	NLF 125-80-400/18,5		45	18,5		
36	NLF 125-80-400/22		50	22		
37	NLF 125-80-400/30		60	30		
38	NLF 125-80-400/37		67	37		
39	NLF 125-100-200/4	100	9	4	1450	
40	NLF 125-100-200/5		11,5	5,5		
41	NLF 125-100-200/5,5		14	7,5		
42	NLF 125-100-200/7,5		16,5	11	1480	
43	NLF 125-100-250/15		25	15		
44	NLF 125-100-315/11		23	15		
45	NLF 125-100-315/18,5		32	18,5		
46	NLF 125-100-315/22		3	22		
47	NLF 125-100-315/30		40	30		
48	NLF 125-100-400/30		50	30		
49	NLF 125-100-400/37		58	37		
50	NLF 125-100-400/45		65	45		
51	NLF 150-125-250/11		200	12,5	11	
52	NLF 150-125-250/15			16	15	
53	NLF 150-125-250/18,5	20		18,5		
54	NLF 150-125-315/30	24		22		
55	NLF 150-125-400/45	32		30		
56	NLF 150-125-315/37	39		37		
57	NLF 150-125-400/45	50		45		

Models 4 Pole

N°	Model	Q(m ³ /h)	H(m)	Motor (kW)	n(r/min)
58	NLF 150-125-400/55	200	57	55	
59	NLF 150-125-400/75		68	75	
60	NLF 200-150-315/37	400	23	37	
61	NLF 200-150-315/45		27	45	
62	NLF 200-150-315/55		32	55	
63	NLF 200-150-315/75		38	75	
64	NLF 200-150-400/75		43	75	
65	NLF 200-150-400/90		50	90	
66	NLF 200-150-400/110		62	110	
67	NLF 250-200-315/37		500	20	37
68	NLF 250-200-315/45	23		45	
69	NLF 250-200-315/55	630	24	55	
70	NLF 250-200-315/75		32	75	
71	NLF 250-200-400/90		37	90	
72	NLF 250-200-400/110		44	110	
73	NLF 250-200-400/132		53	132	
74	NLF 250-200-400/160		60	160	
75	NLF 300-250-315/75	800	26	75	
76	NLF 300-250-315/90		32	90	
77	NLF 300-250-315/110		35	110	
78	NLF 300-250-400/110	800	38	110	
79	NLF 300-250-400/132		45	132	
80	NLF 300-250-400/160		53	160	
81	NLF 300-250-400/200		63	200	

NLF/NLFB/NLFB/NLX Sectional drawing

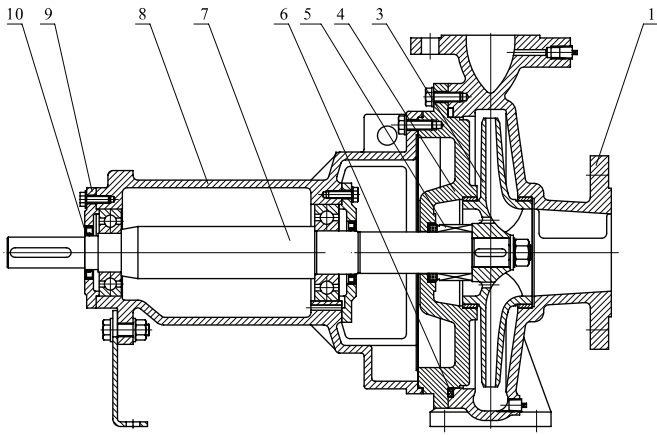

NLF/NLFB/NLFB/NLX Part list

N°	Parts	Material	AISI/ASTM
1	Casing	Nodular Cast Iron / AISI304	ASTM A536 / AISI304
2	Wear ring	Nodular Cast Iron	ASTM A536
3	Impeller	Nodular Cast Iron / AISI 304 Bronze	ASTM A536 / AISI304
4	Casing cover	Nodular Cast Iron	ASTM A536
5	Mechanical seal	Carbon / Silicon Carbide	
6	O ring	NBR	
7	Shaft	Stainless Steel 420	AISI420
8	Bearing housing	Nodular Cast Iron	ASTM A536
9	Bearing cover	Nodular Cast Iron	ASTM A536
10	Seal	NBR	

NF, NFX Sectional drawing

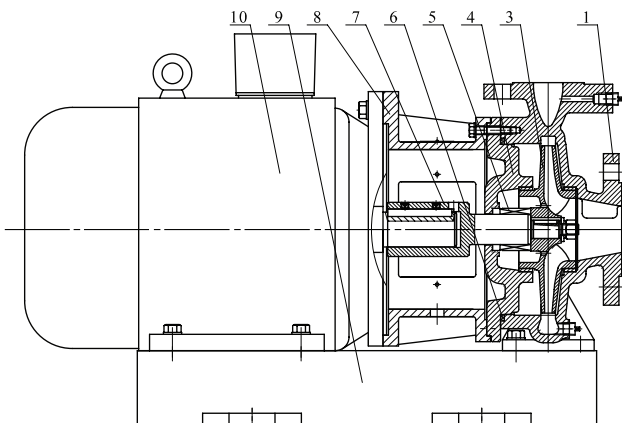

NF, NFX Part list

N°	Parts	Material	AISI/ASTM
1	Casing	Nodular Cast Iron / ZG07Cr19Ni9	ASTM A536 / AISI304
3	Impeller	Nodular Cast Iron / ZG07Cr19Ni9 / Bronze	ASTM A536 / AISI304
4	Casing cover	Nodular Cast Iron / ZG07Cr19Ni9	ASTM A536 / AISI304
5	Mechanical seal	Carbon / Silicon Carbide	
6	O ring	NBR	
7	Shaft	Stainless Steel 420	AISI420
8	Head	Nodular Cast Iron	ASTM A536
9	Baseplate		ASTM A536
10	Motor		

NLF / NLFX / NF / NFX 50-32-160 / 50-32-200 / 65-40-200

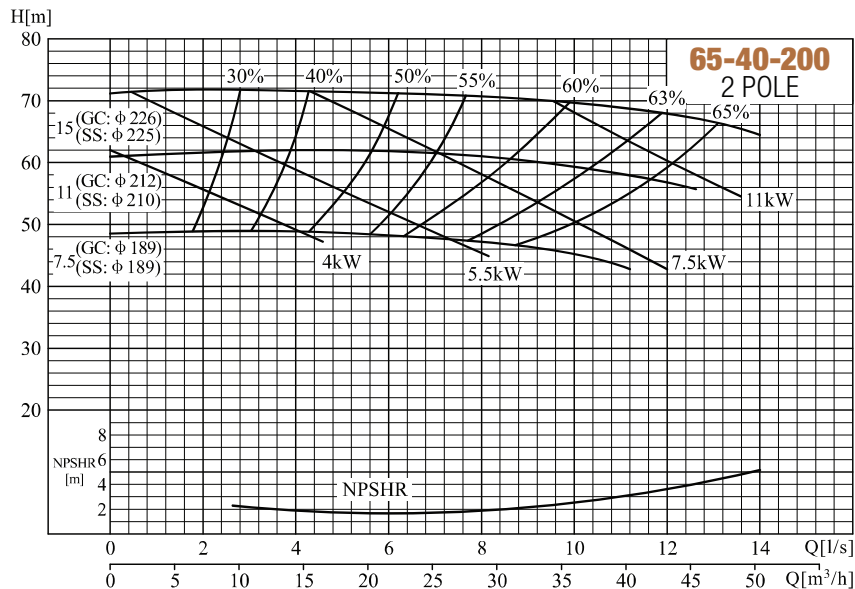
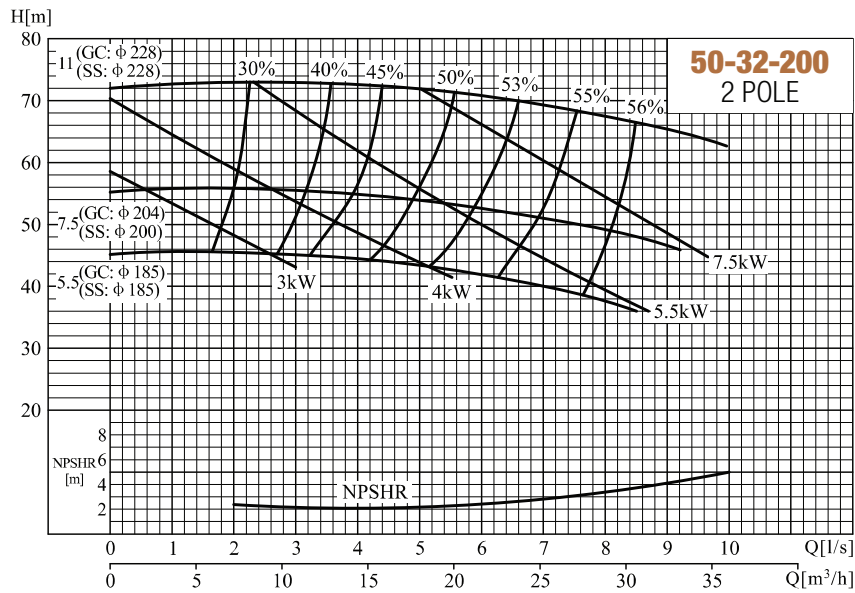
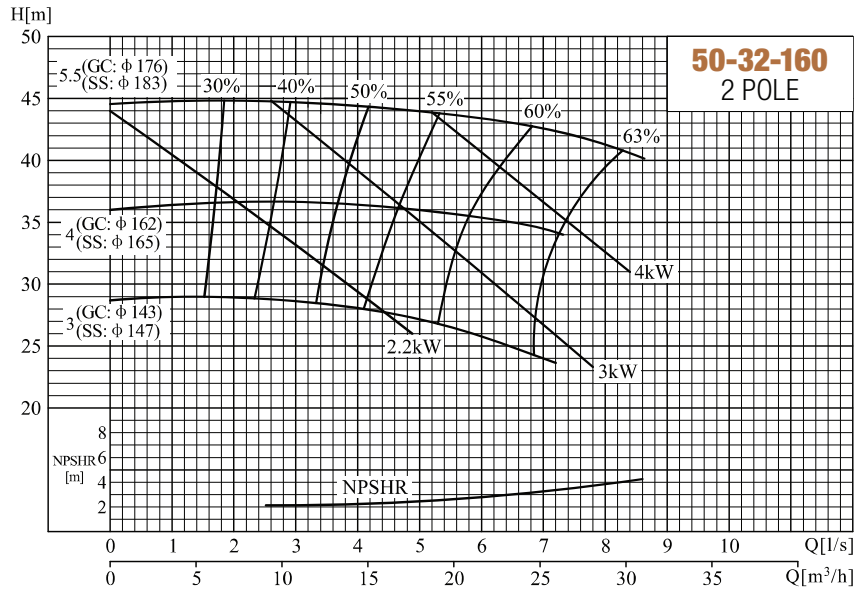

NLF / NLFX / NF / NFX 65-40-250 / 65-40-315 / 65-50-160

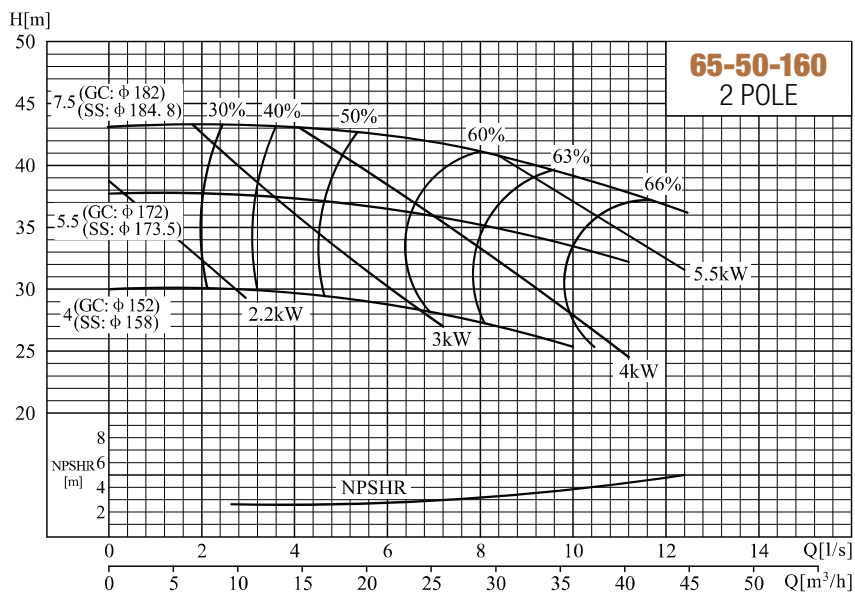
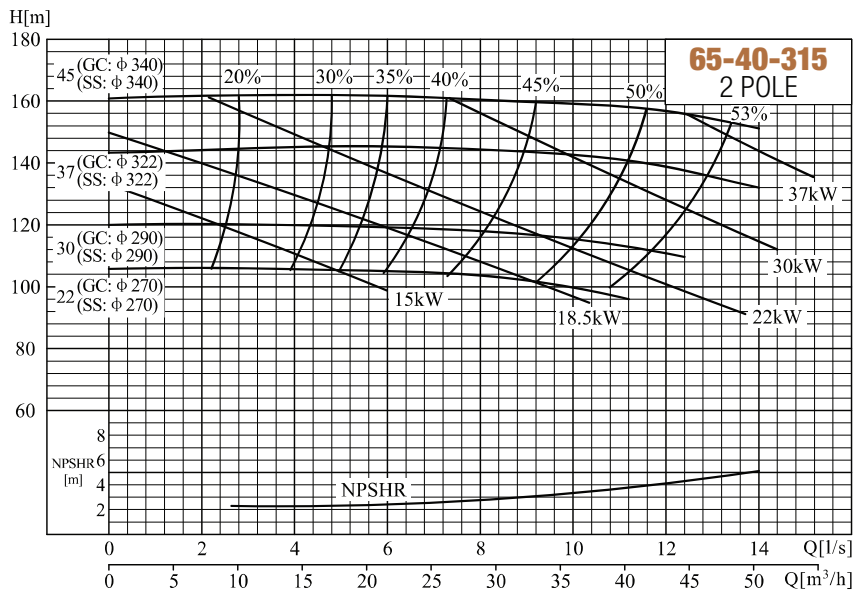
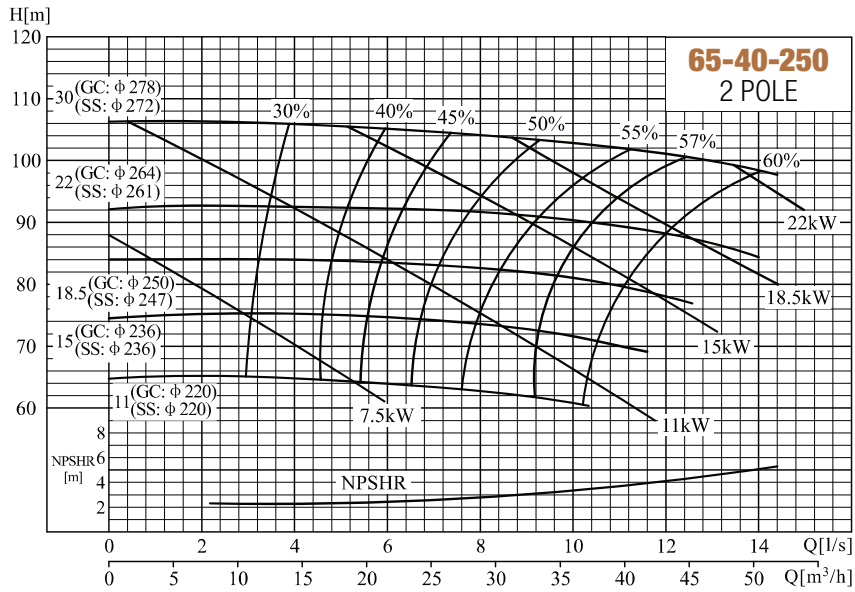

NLF / NLFX / NF / NFX 80-50-200 / 80-50-250 / 80-50-315

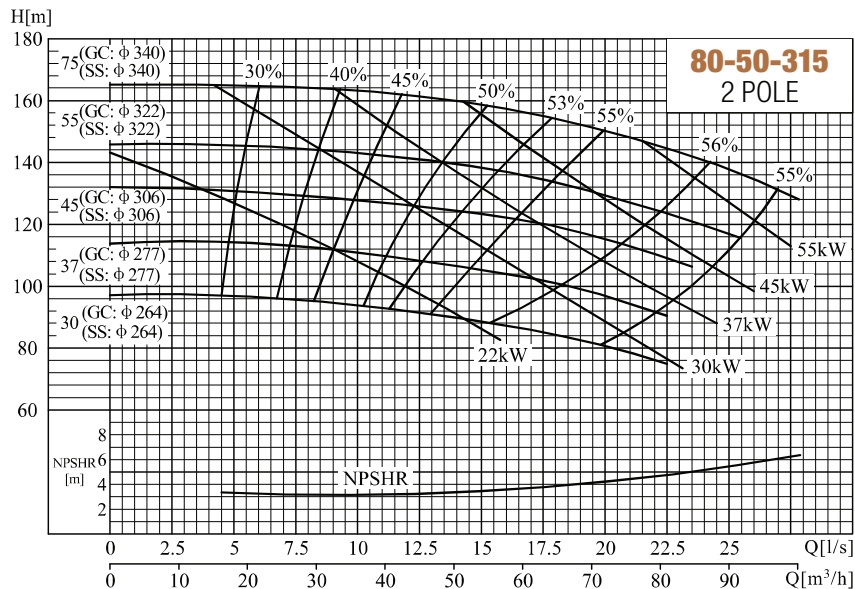
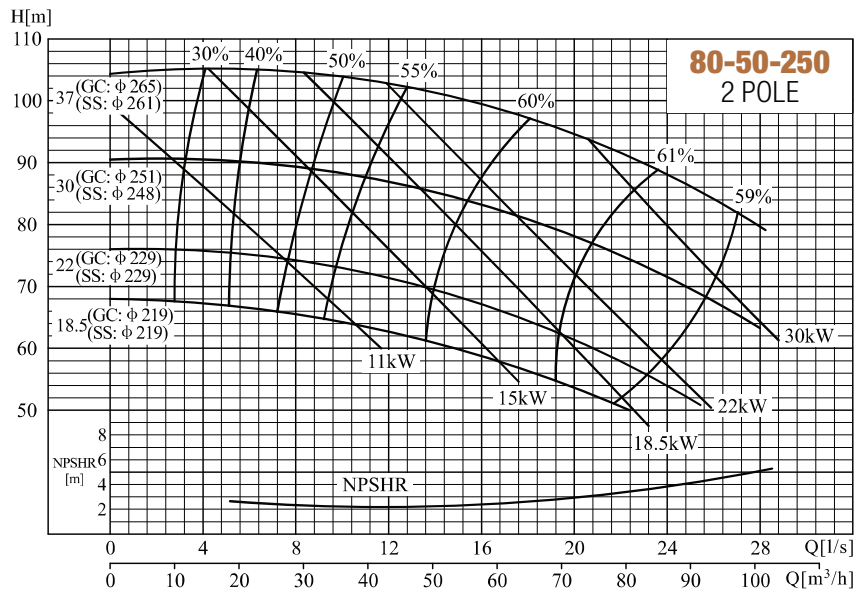
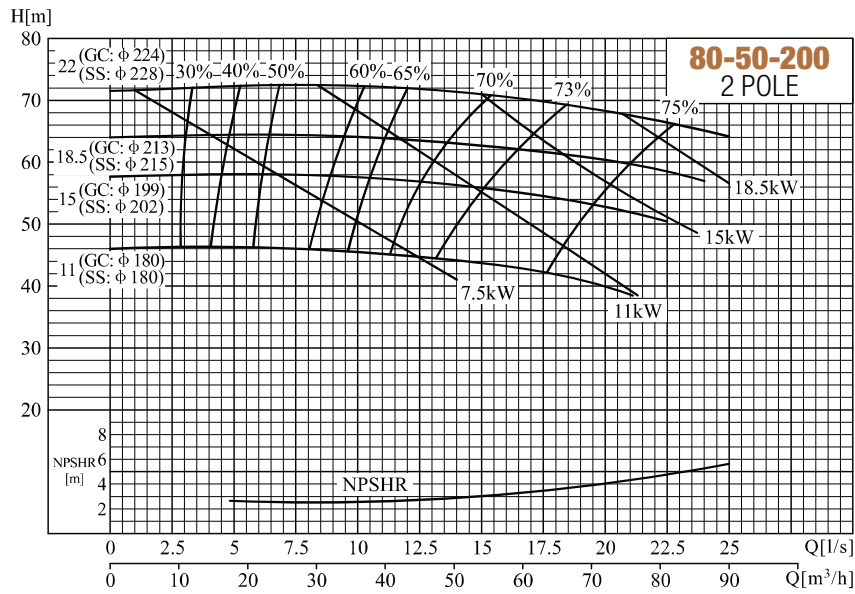

NLF / NLFX / NF / NFX 80-65-160 / 100-65-200 / 100-65-250

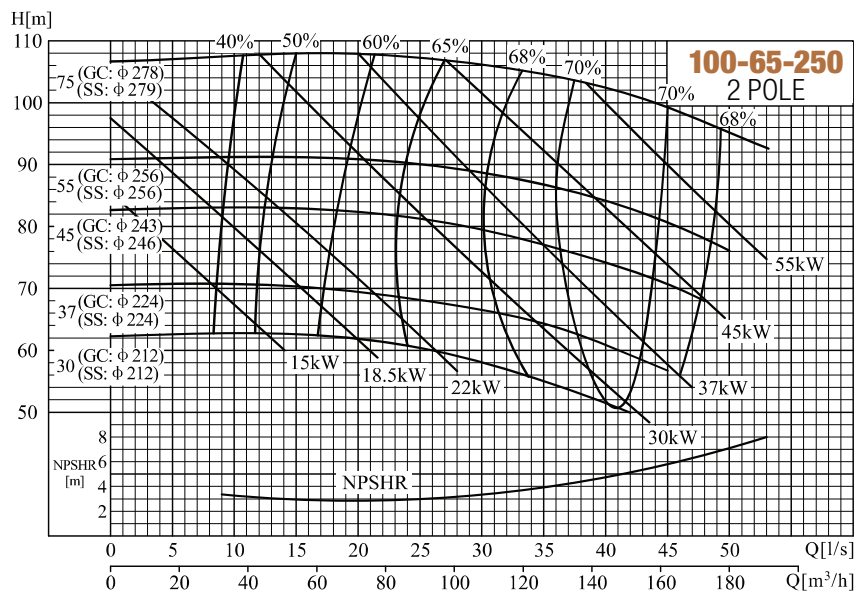
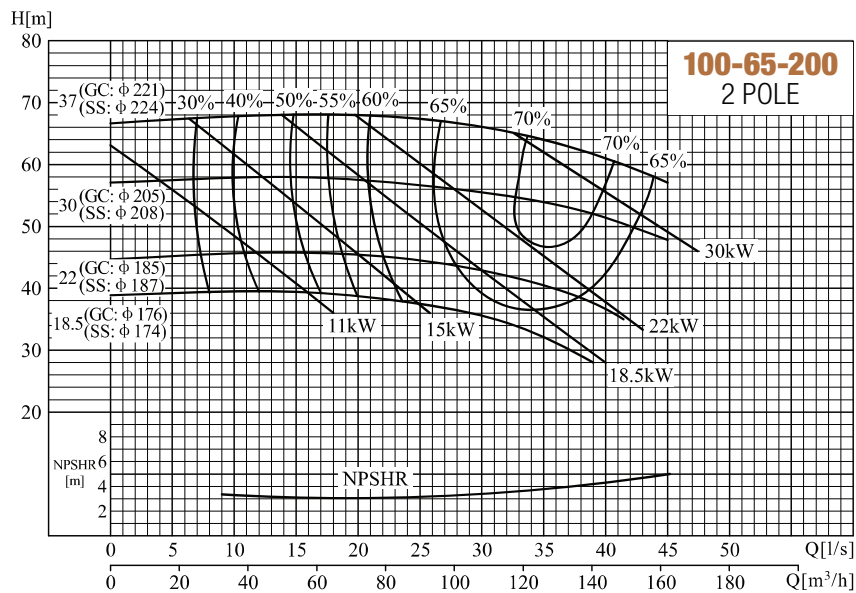
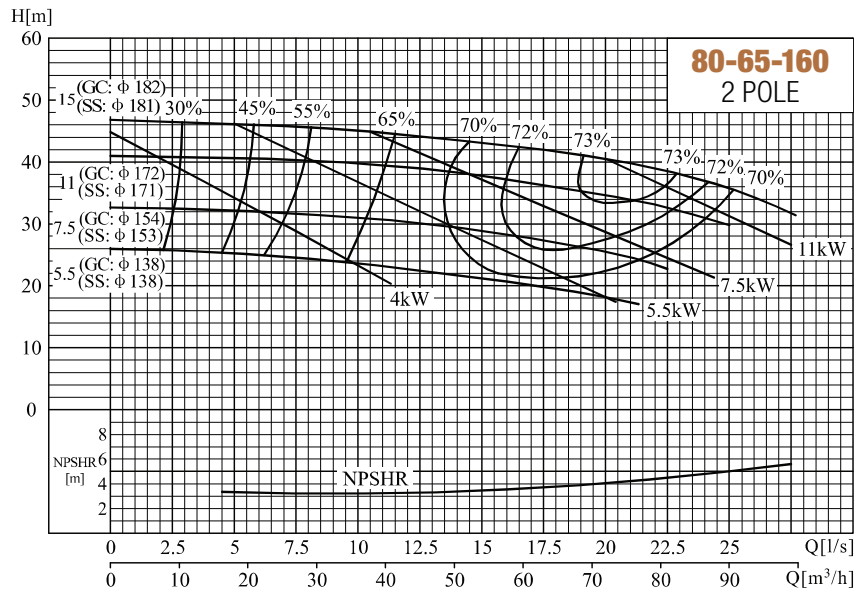

NLF / NLFX / NF / NFX 100-65-315 / 100-80-160 / 125-100-200

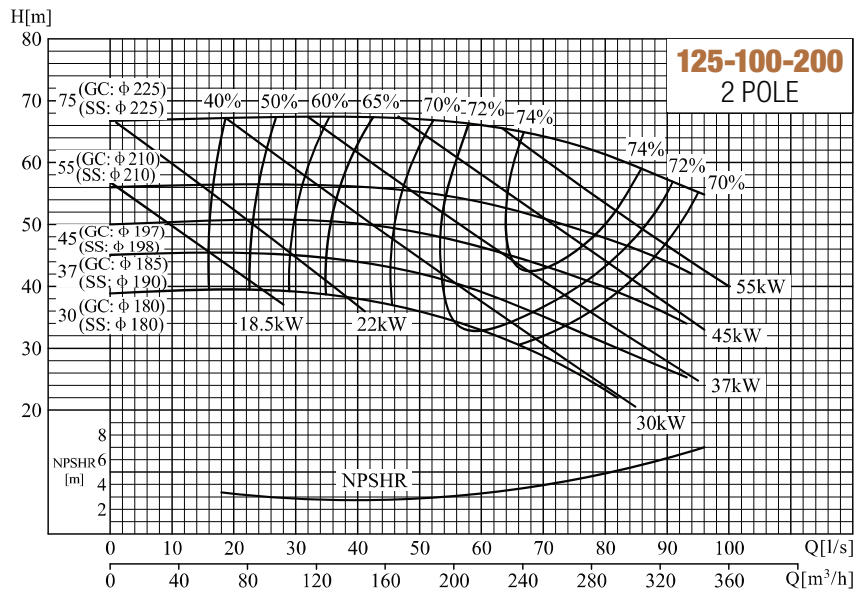
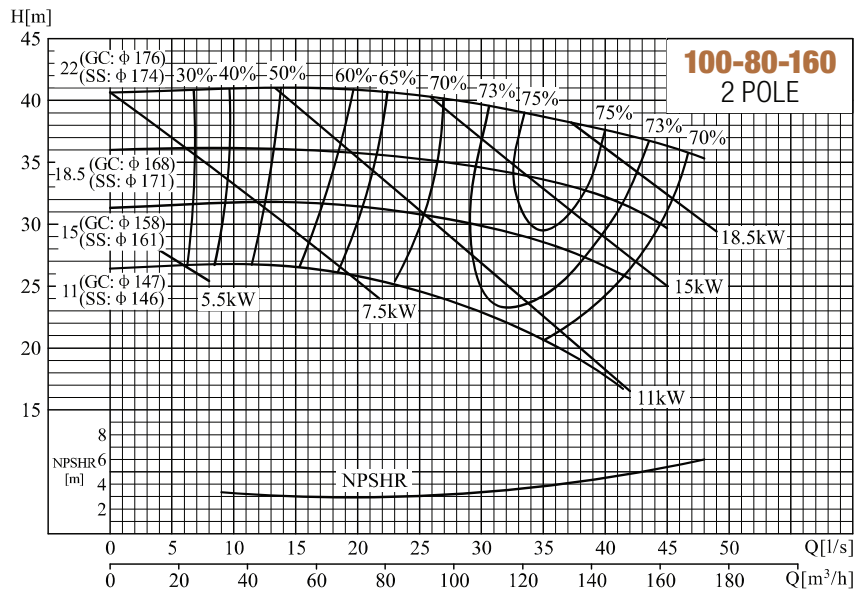
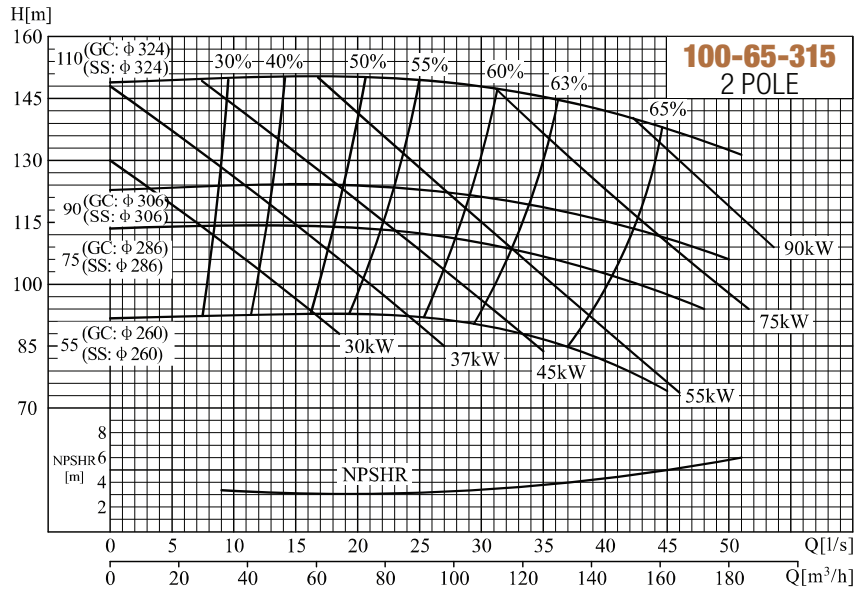

NLF / NLFX / NF / NFX 125-100-250 / 125-100-315 / 50-32-160

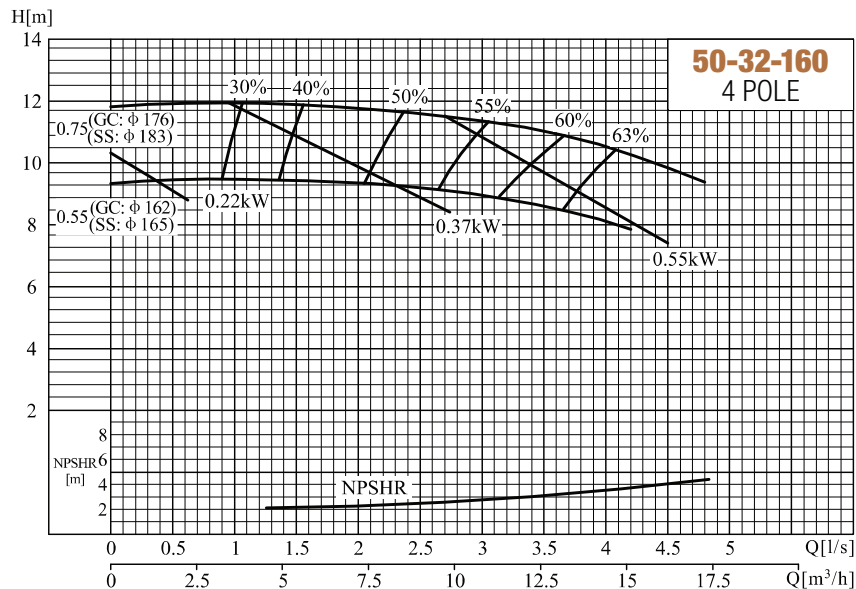
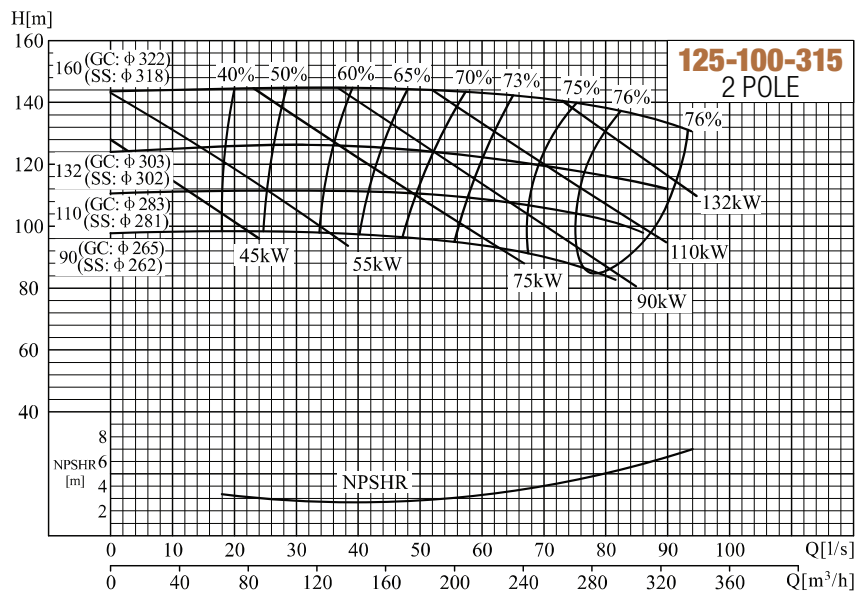
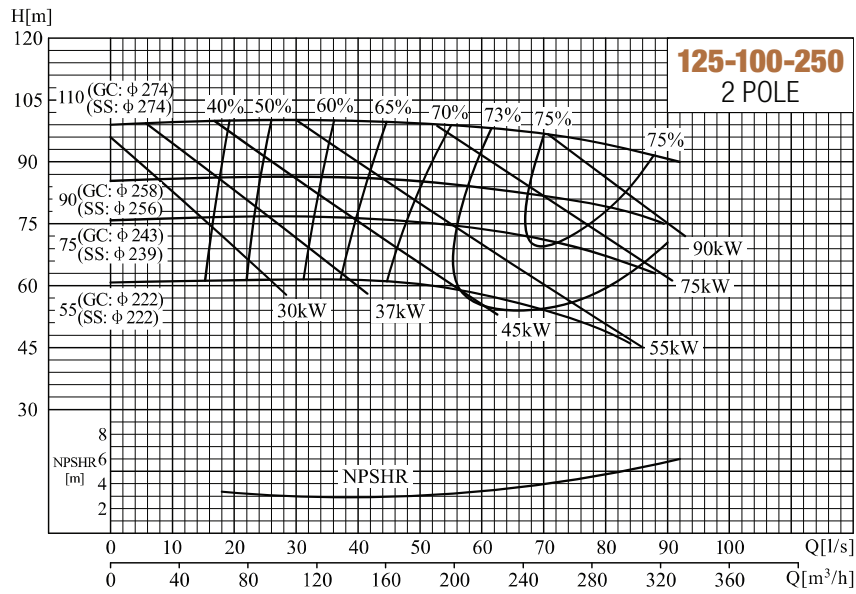

NLF / NLFX / NF / NFX 50-32-200 / 65-40-200 / 65-40-250

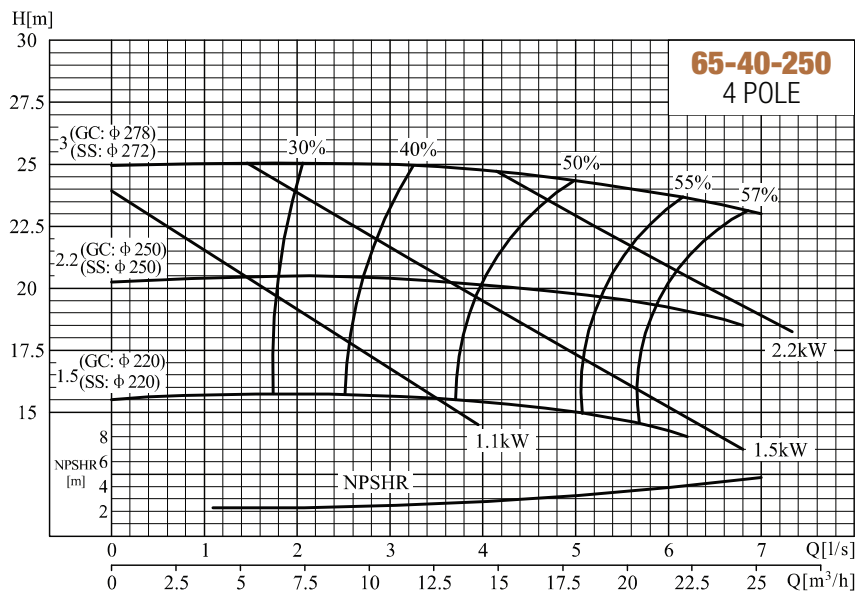
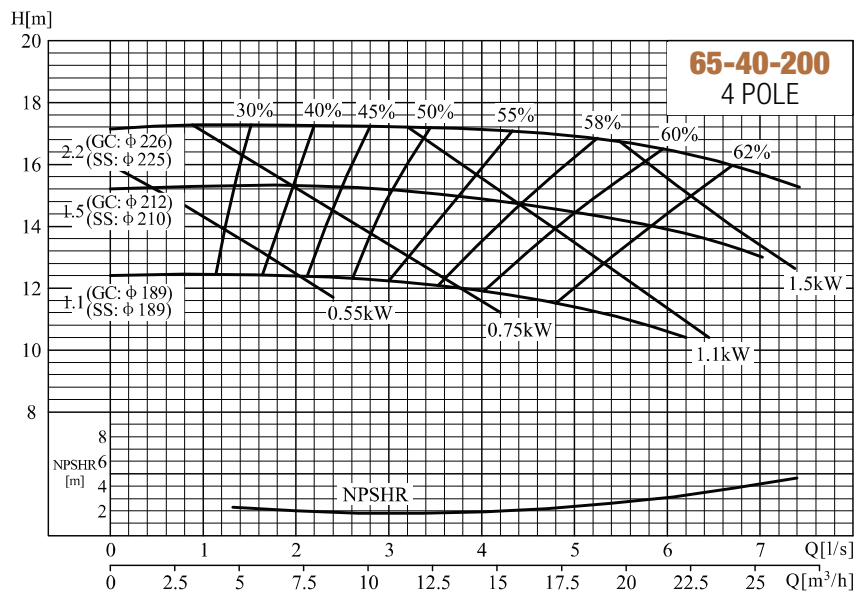
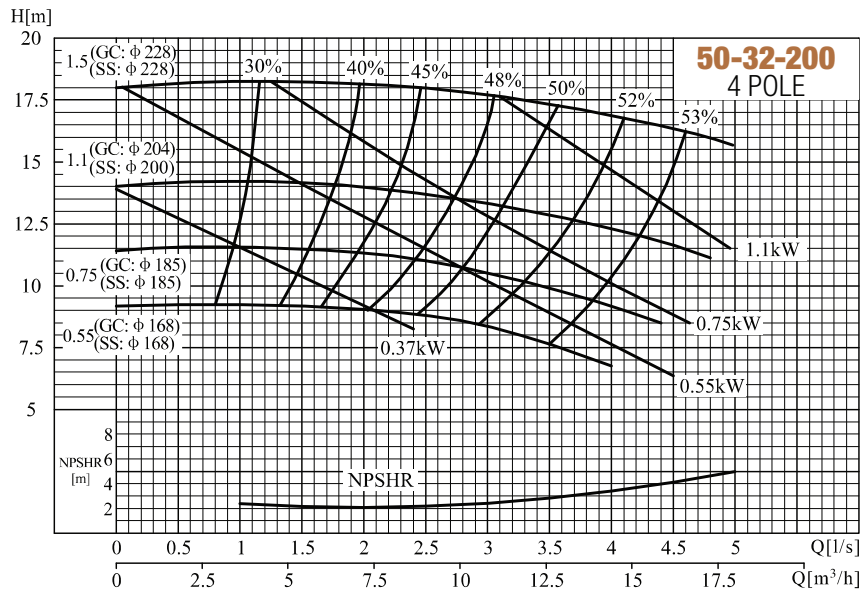

NLF / NLFX / NF / NFX 65-40-315 / 65-50-160 / 80-50-200

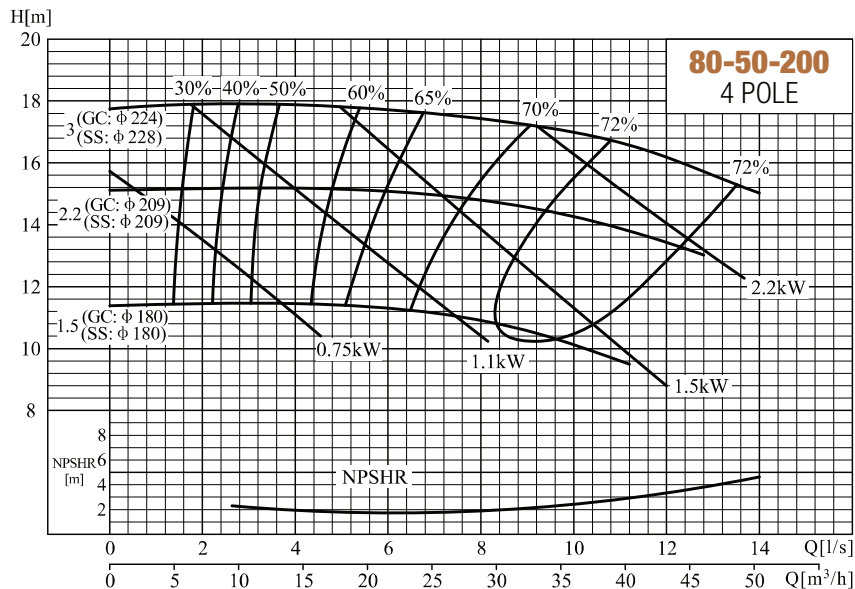
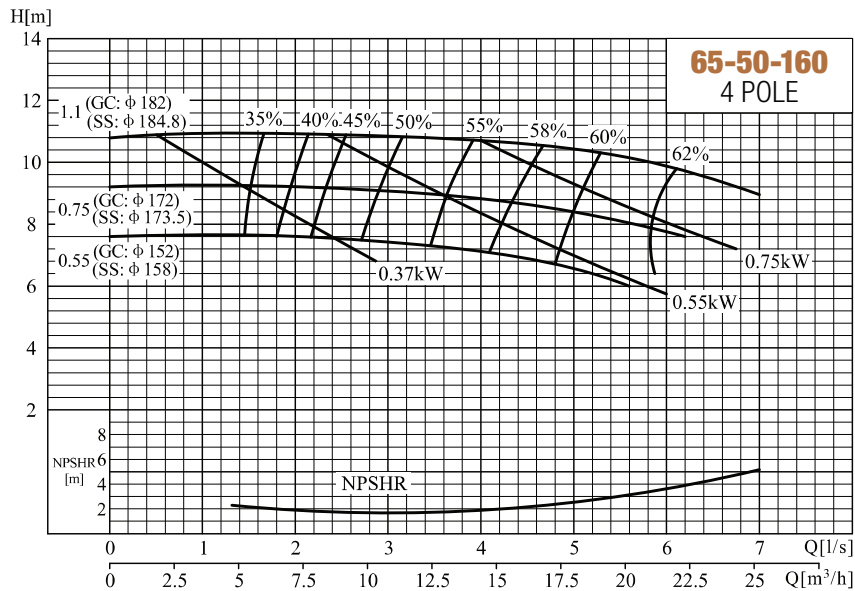
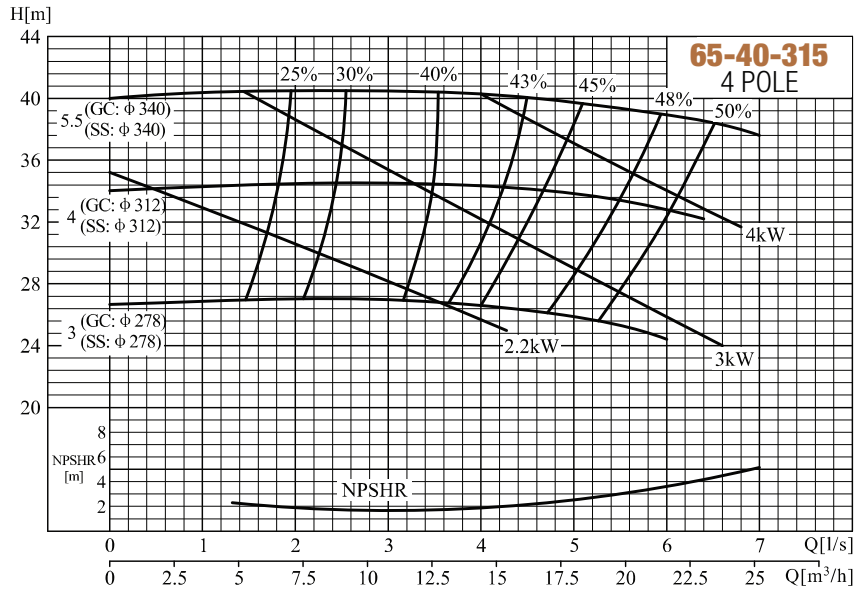

NLF / NLFX / NF / NFX 80-50-250 / 80-50-315 / 80-65-160

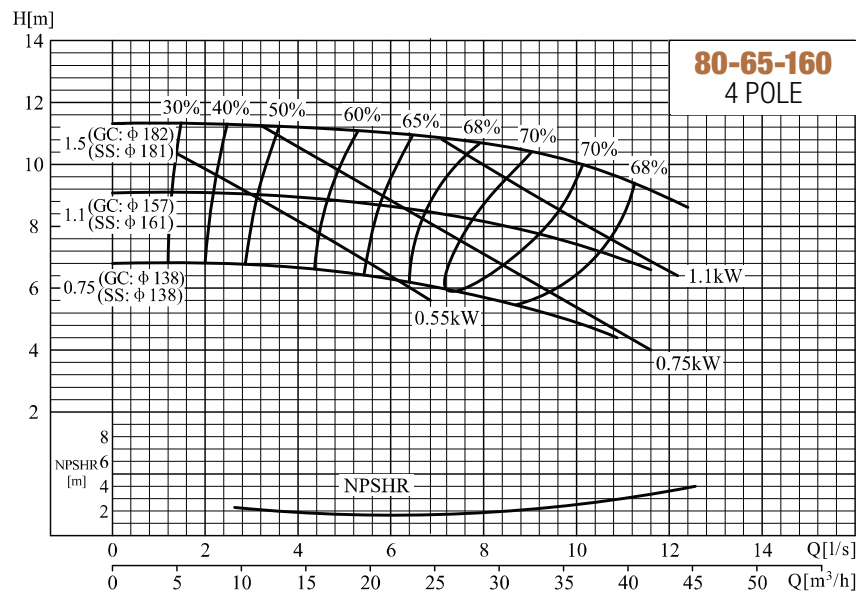
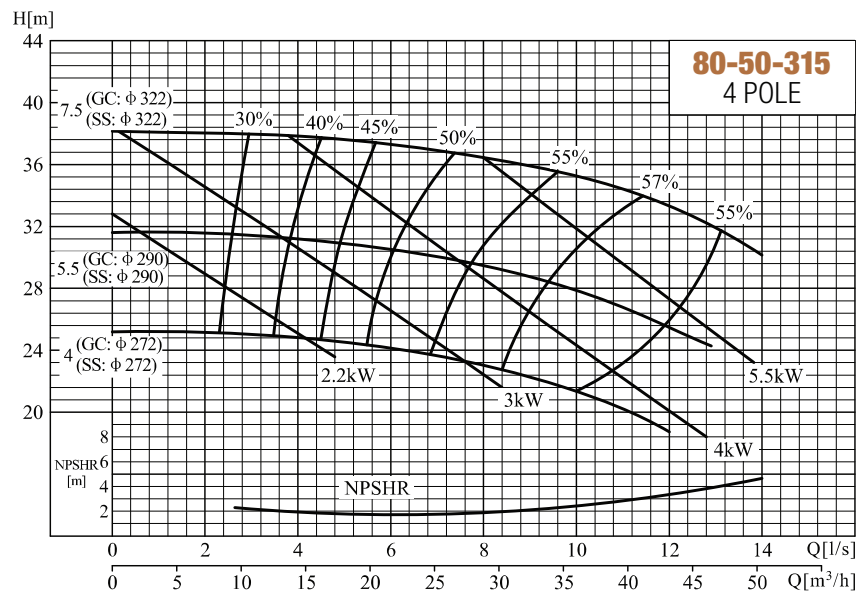
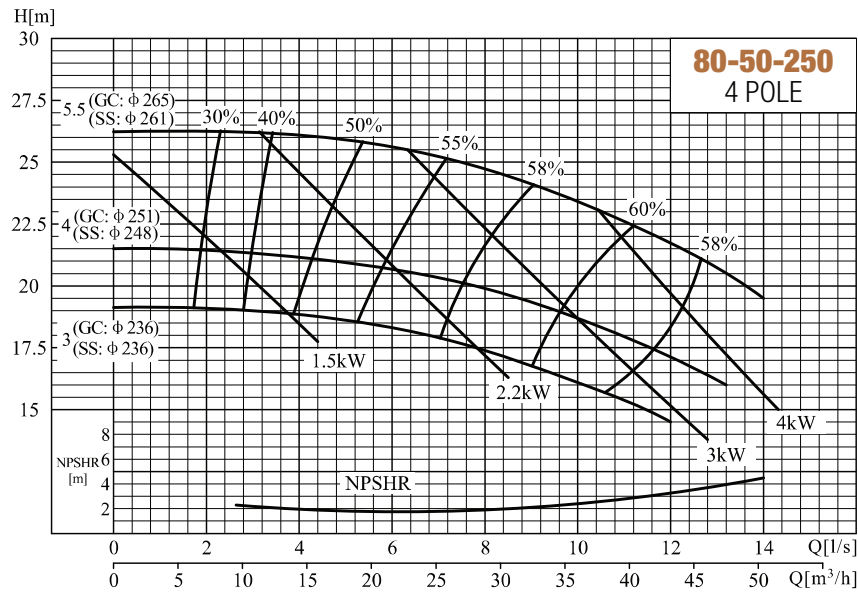

NLF / NLFX / NF / NFX 100-65-200 / 100-65-250 / 100-65-315

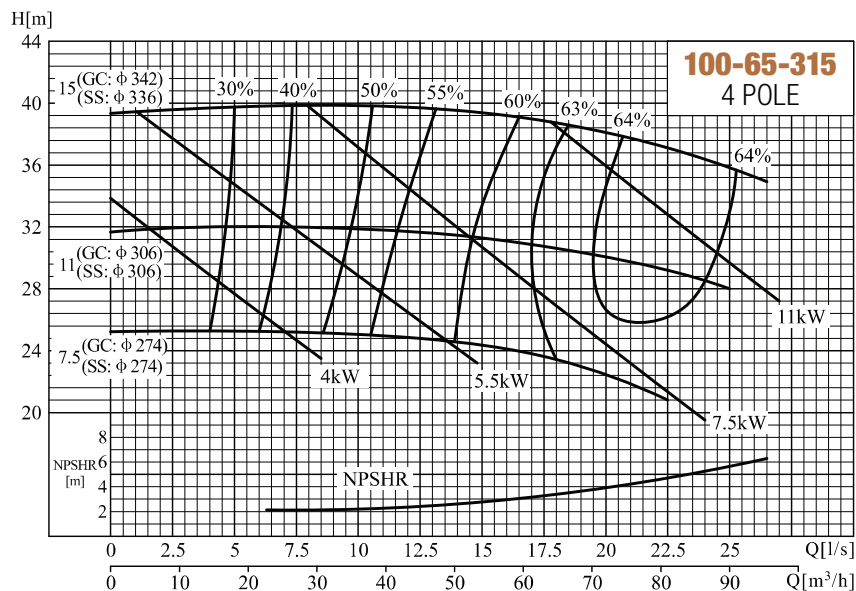
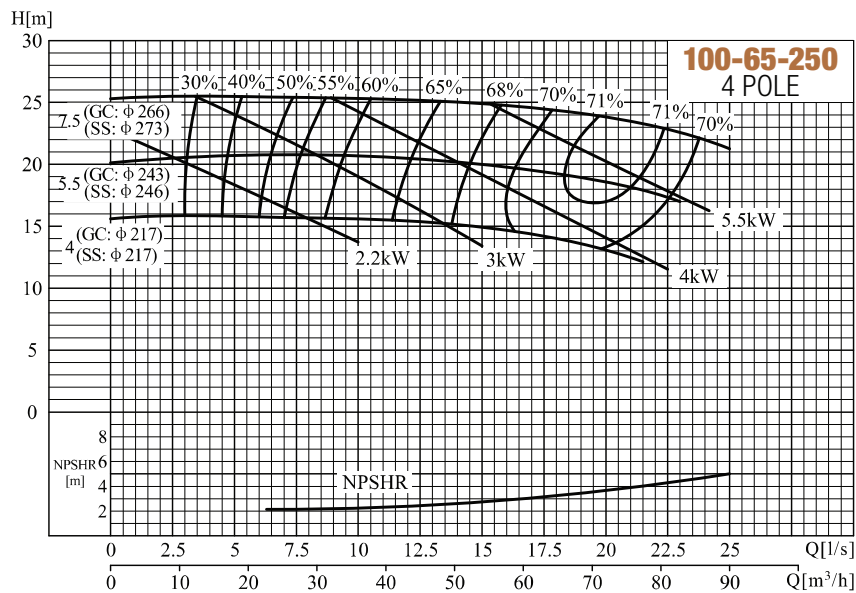
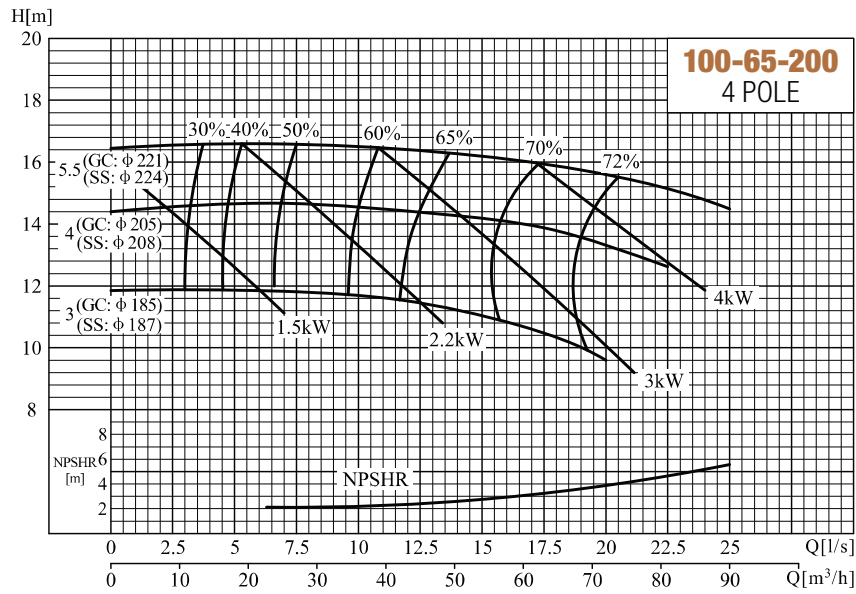

NLF / NLFX / NF / NFX 100-80-160 / 125-100-200 / 125-100-250

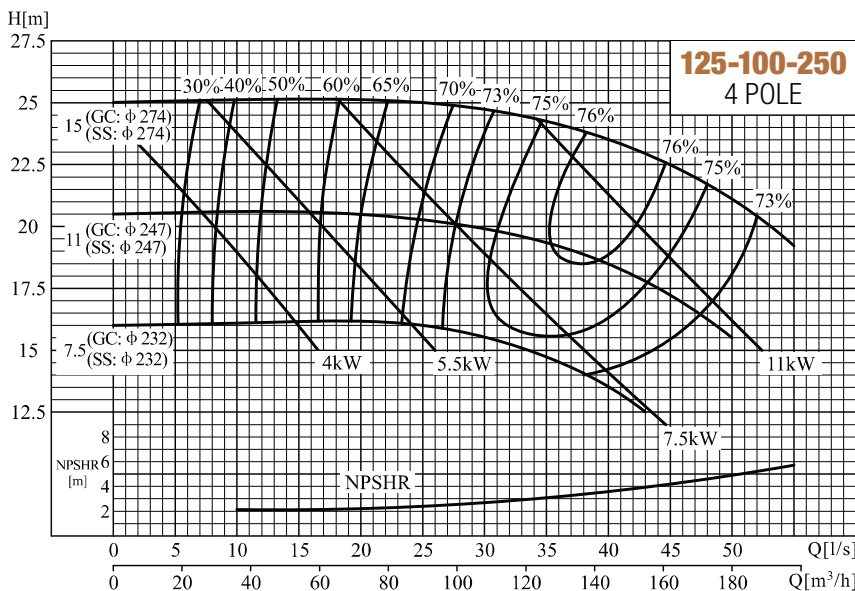
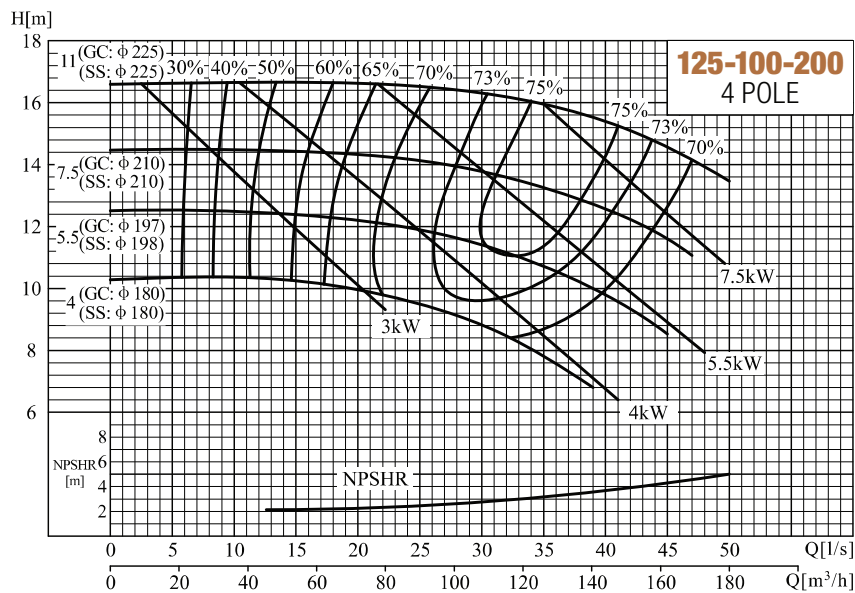
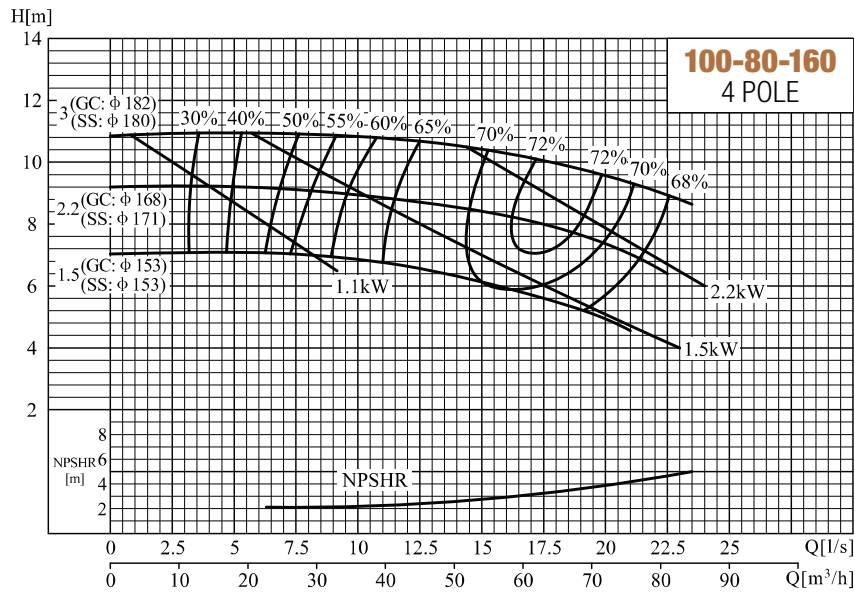

NLF / NLFX / NF / NFX 125-100-315 / 125-80-400 / 125-100-400

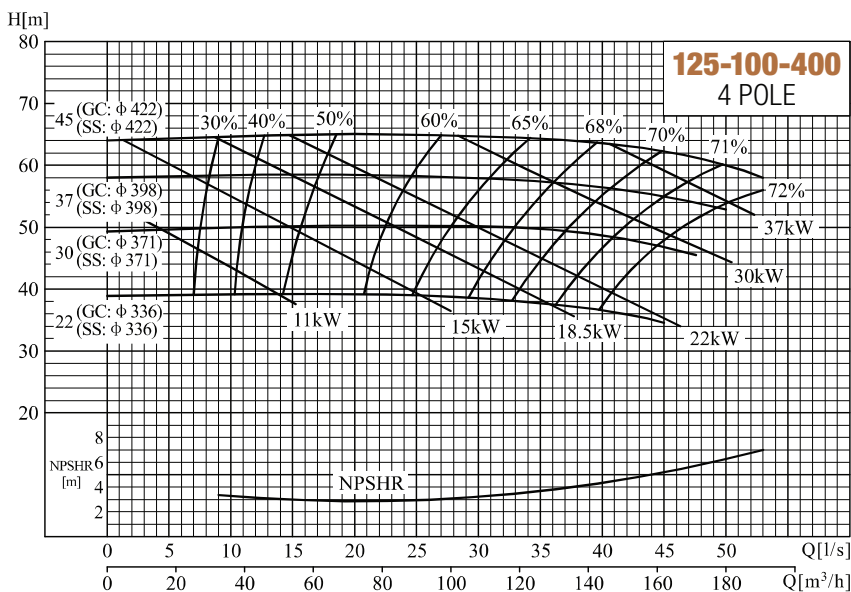
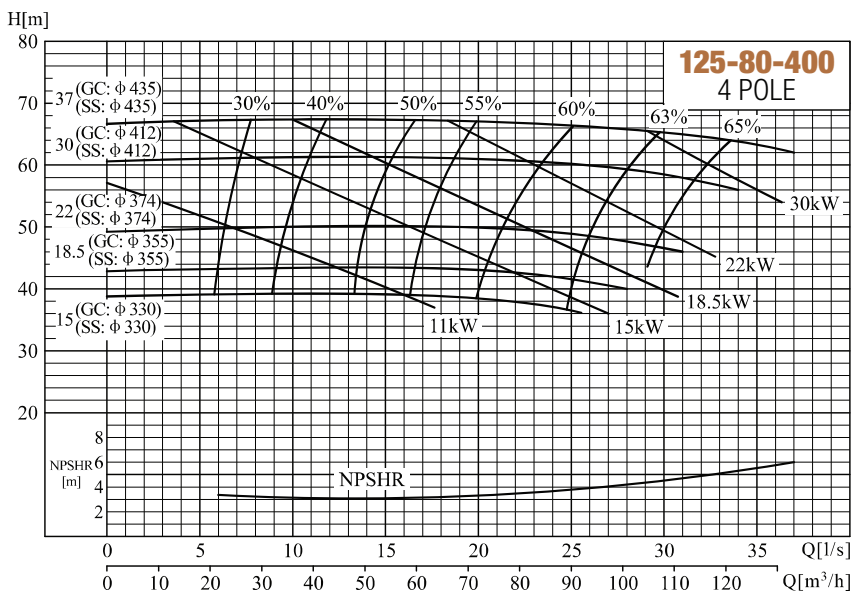
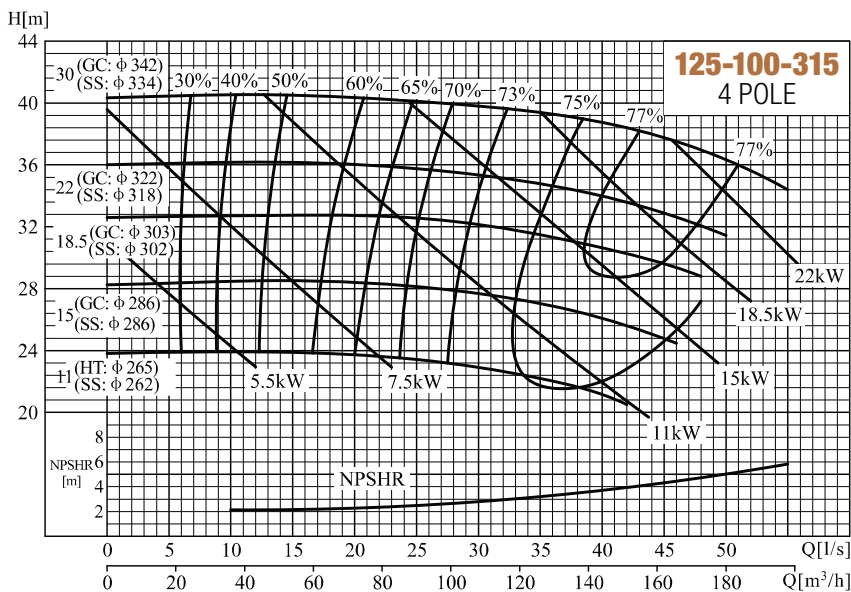

NLF / NLFX / NF / NFX 150-125-250 / 150-125-315 / 150-125-400

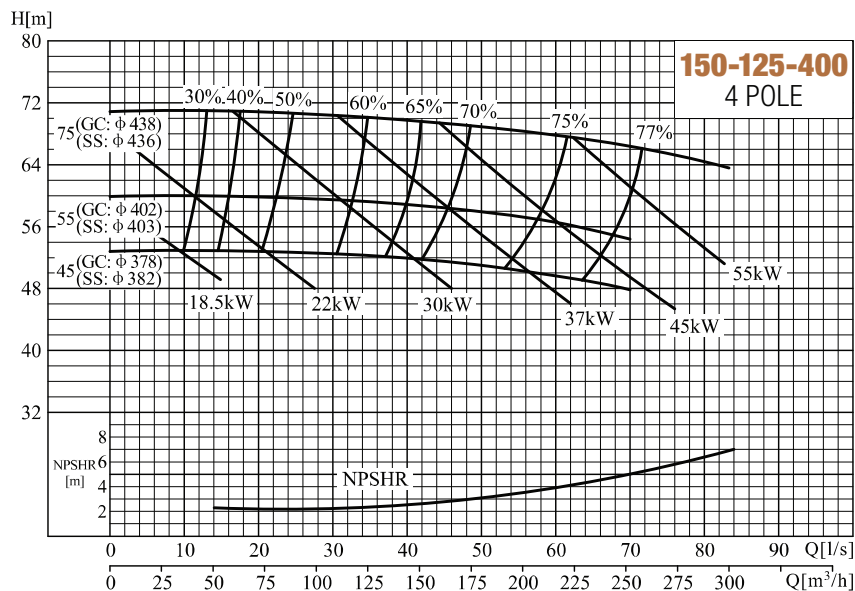
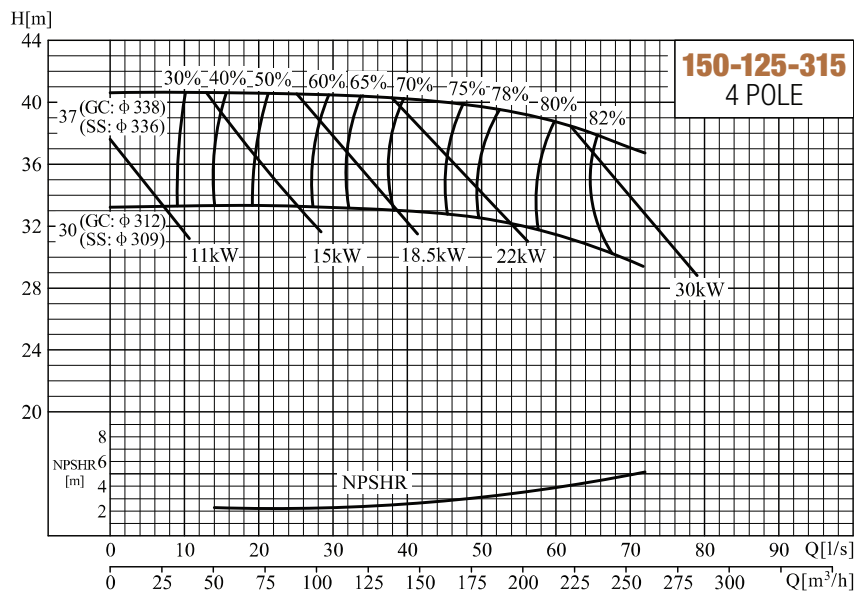
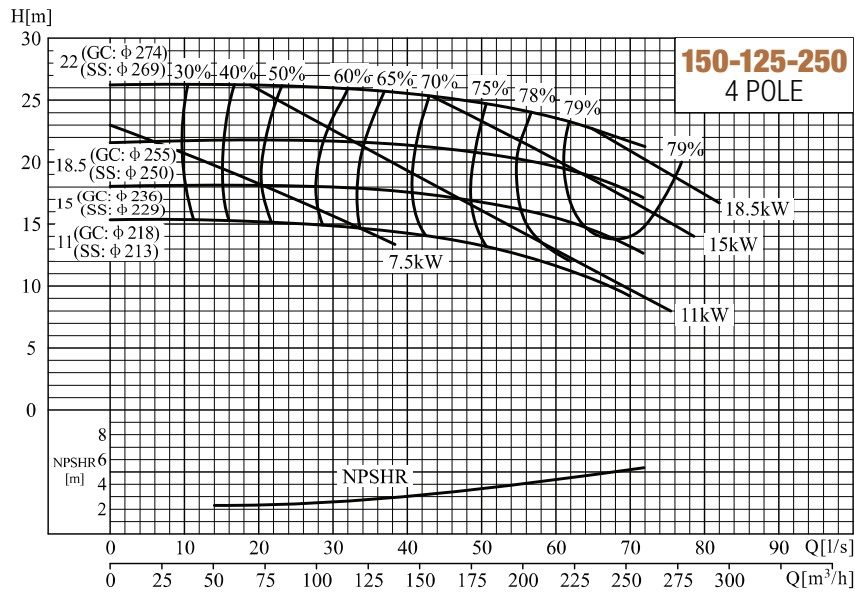

NLF / NLFX / NF / NFX 200-150-315 / 200-150-400

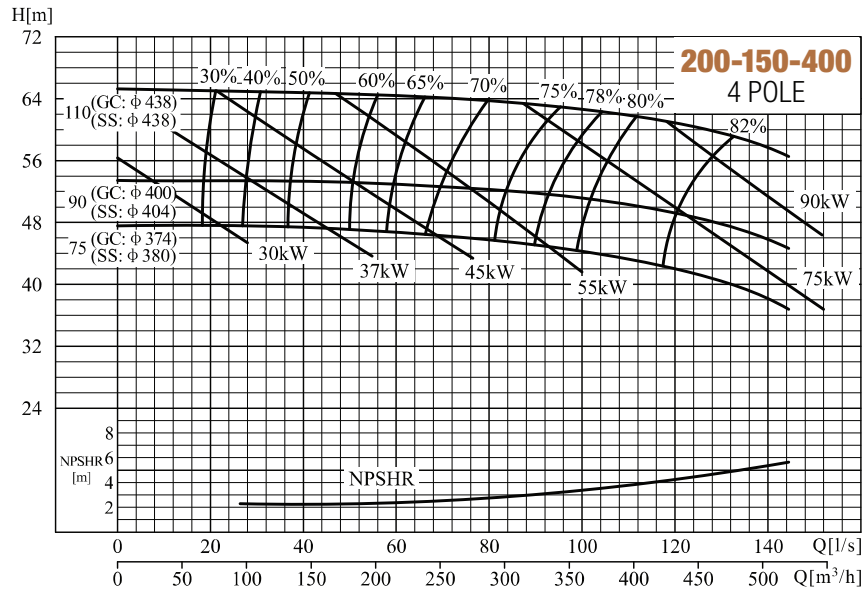
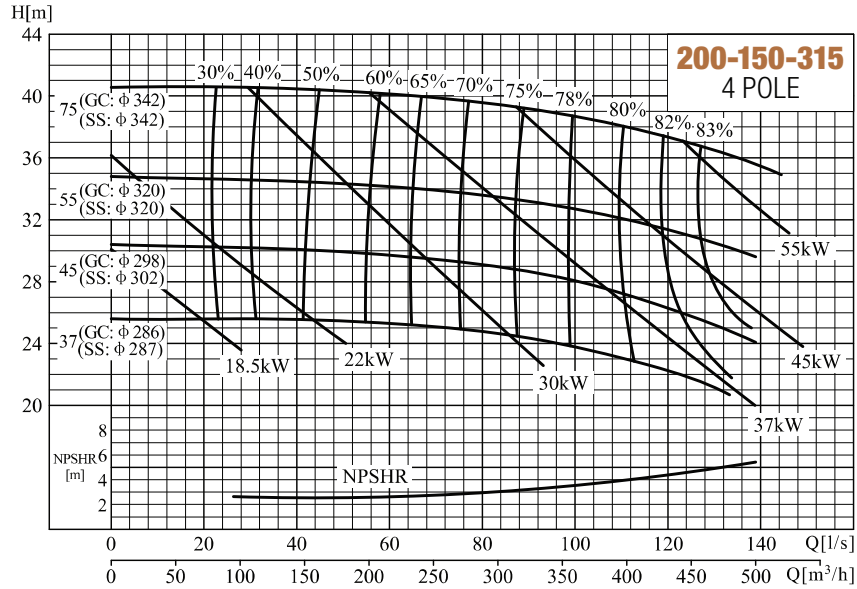

NLF / NLFX / NF / NFX 250-200-315 / 250-200-400

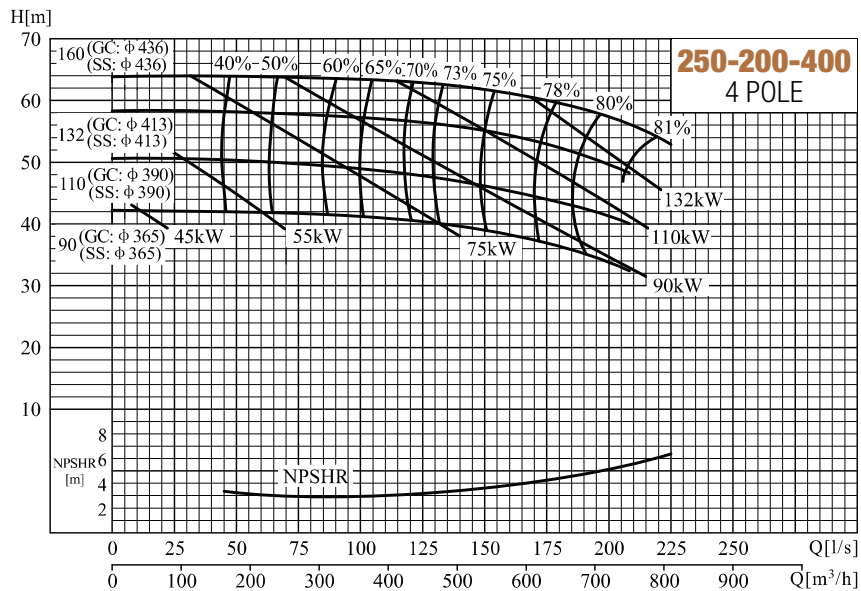
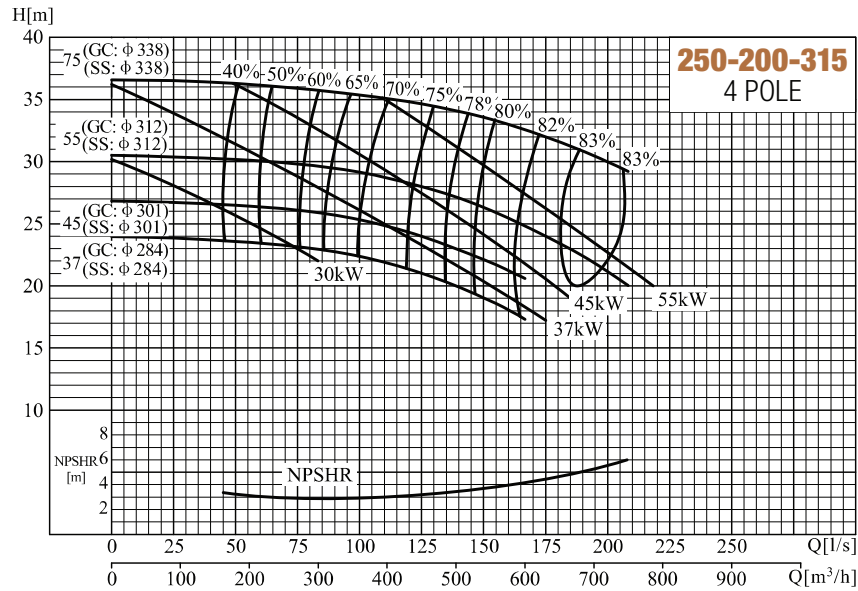

aFEGUR CYR

NLF / NLFX / NF / NFX 300-250-315 / 300-250-400

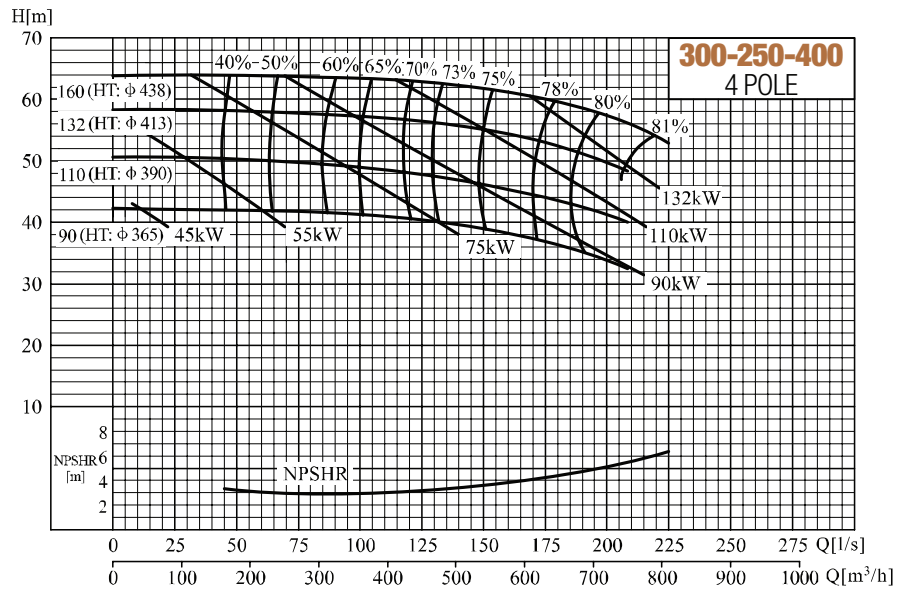
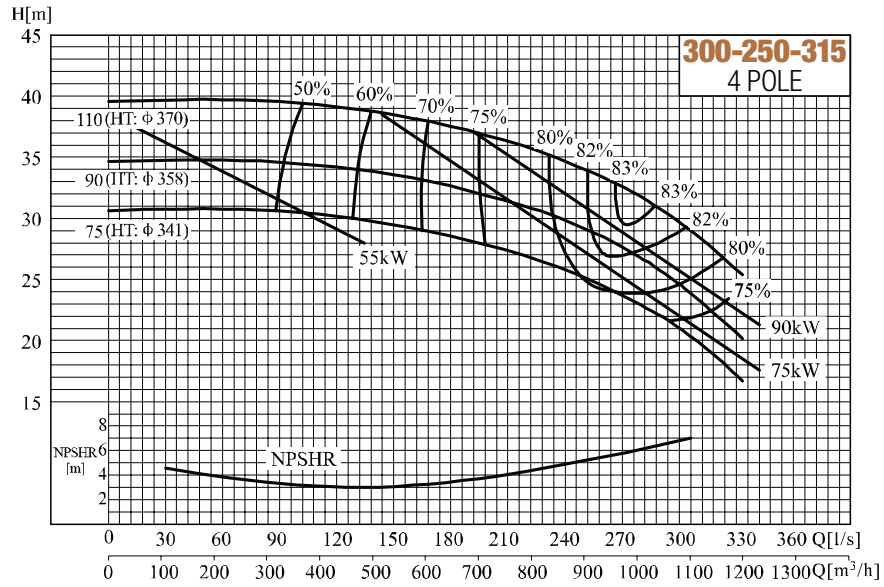

NLF / NLFX / NLFB / NLX / NLN Pump dimensions

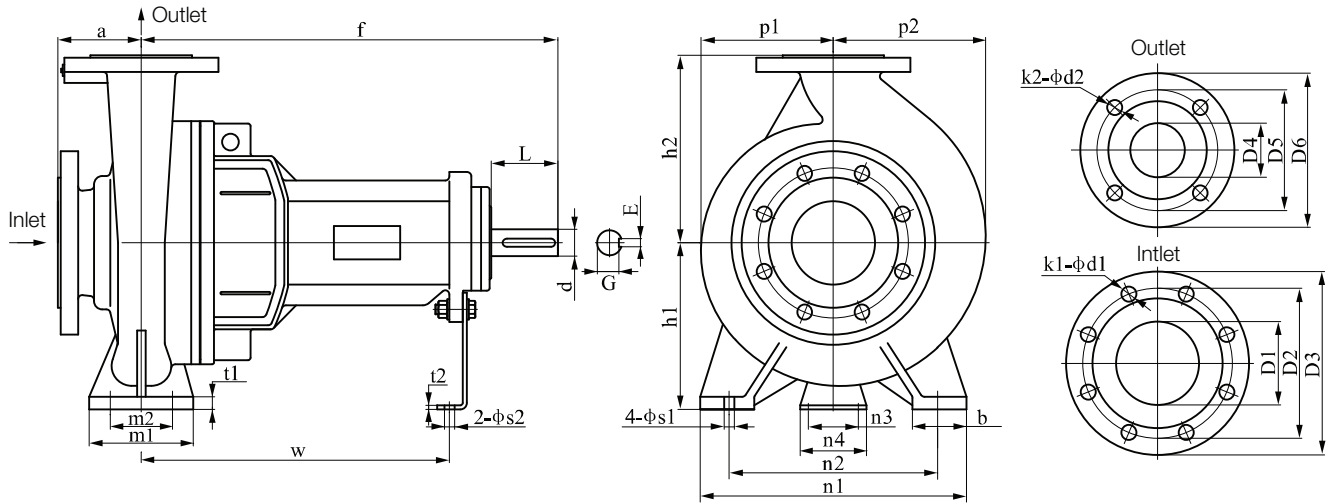

NLF / NLFX / NLFB / NLX / NLN Pump dimension table

N°	Model	Pump size					Installation dimension										Inlet flange size				Outlet flange size				Size of pump shaft extension				Weight (Kg)					
		a	f	h1	h2	b	p1	p2	m1	m2	n1	n2	n3	n4	t1	t2	w	s1	s2	D1	D2	D3	k1	d1	D4	D5	D6	k2		d2	D	L	E	G
1	50-32-160	80	385	132	160	50	118	128	100	70	240	190	110	160	12	6	285	14	14	50	125	165	4	18	32	100	140	4	18	24	50	8	20	40
2	50-32-200	80	385	160	180	50	139	147	100	70	240	190	110	160	12	6	285	14	14	50	125	165	4	18	32	100	140	4	18	24	50	8	20	48
3	65-50-160	80	385	132	160	50	121	136	100	70	240	190	110	160	12	6	285	14	14	65	145	185	4	18	50	125	165	4	18	24	50	8	20	42
4	65-40-200	100	385	160	180	50	140	151	100	70	265	212	110	160	13	6	285	14	14	65	145	185	4	18	40	110	150	4	18	24	50	8	20	50
5	65-40-250	100	500	180	225	65	166	176	125	95	320	250	110	160	14	6	370	14	14	65	145	185	4	18	40	110	150	4	18	32	80	10	27	72
6	65-40-315	125	500	200	250	65	194	200	125	95	345	280	110	160	16	6	370	14	14	65	145	185	4	18	40	110	150	4	18	32	80	10	27	82
7	80-65-160	100	385	160	180	50	124	143	100	70	265	212	110	160	13	6	285	14	14	80	160	200	8	18	65	145	185	4	18	24	50	8	20	48
8	80-50-200	100	385	160	200	52	147	161	100	70	320	212	110	160	13	6	285	14	14	80	160	200	8	18	50	125	165	4	18	24	50	8	20	54
9	80-50-250	125	500	180	225	65	167	179	125	95	345	250	110	160	15	6	370	14	14	80	160	200	8	18	50	125	165	4	18	32	80	10	27	75
10	80-50-315	125	500	225	280	65	204	215	125	95	320	280	110	160	18	6	370	14	14	80	160	200	8	18	50	125	165	4	18	32	80	10	27	90
11	100-65-200	100	500	180	225	65	159	183	125	95	360	250	110	160	14	6	370	14	14	100	180	220	8	18	65	145	18	4	18	32	80	10	27	73
12	100-65-250	125	500	200	250	80	180	201	160	120	400	280	110	160	16	6	370	18	14	100	180	220	8	18	65	145	185	4	18	32	80	10	27	82
13	100-65-315	125	530	225	280	80	210	228	160	120	180	315	110	160	18	6	370	18	14	100	180	220	8	18	65	145	185	4	18	42	110	12	37	120
14	100-80-160	100	500	160	200	65	132	160	125	95	435	212	110	160	14	6	370	14	14	100	180	220	8	18	80	160	200	8	18	32	80	10	27	70
15	125-80-400	125	530	280	355	80	261	279	160	120	360	355	110	160	20	6	370	18	14	125	210	250	8	18	80	160	200	8	18	42	110	12	37	168
16	125-100-200	125	500	200	280	80	175	210	160	120	400	280	110	160	17	6	370	18	14	125	210	250	8	18	100	180	220	8	18	32	80	10	27	88
17	125-100-250	140	530	225	280	80	193	225	160	120	400	315	110	160	18	6	370	18	14	125	210	250	8	18	100	180	220	8	18	42	110	12	37	130
18	125-100-315	140	530	250	315	80	224	250	160	120	500	315	110	160	19	6	370	18	14	125	210	250	8	18	100	180	220	8	18	42	110	12	37	138
19	150-100-400	140	530	280	355	100	265	287	200	150	400	400	110	160	20	6	370	18	14	125	210	250	8	18	100	180	220	8	18	42	110	12	37	178
20	150-125-250	140	530	250	355	80	204	244	160	120	500	315	110	160	19	6	370	18	14	150	240	285	8	22	125	210	250	8	18	42	106	12	37	134
21	150-125-315	140	530	280	355	100	236	271	200	150	500	400	110	160	20	6	370	22	14	150	240	285	8	22	125	210	250	8	18	42	106	12	37	167
22	150-125-400	140	530	315	400	100	273	301	200	150	500	400	110	160	21	6	370	22	14	150	240	285	8	22	125	210	250	8	18	42	106	12	37	186
23	200-150-315	160	670	315	400	82	255	304	200	150	515	450	140	180	25	10	500	22	18	200	295	340	12	22	150	240	285	8	22	60	110	18	53	228
24	200-150-400	160	670	315	450	82	291	330	200	150	515	450	140	180	25	10	500	22	18	200	295	340	12	22	150	240	285	8	22	60	110	18	53	285
25	250-200-315	180	670	315	450	82	278	344	200	150	515	450	140	180	25	10	500	22	18	250	355	405	12	26	200	395	340	12	22	60	110	18	53	264
26	250-200-400	180	670	380	450	82	314	367	200	150	515	450	140	180	25	10	500	22	18	250	355	405	12	26	200	395	340	12	22	60	110	18	53	335

NLF / NLFX / NLFB / NLX / NLN Pump set dimension

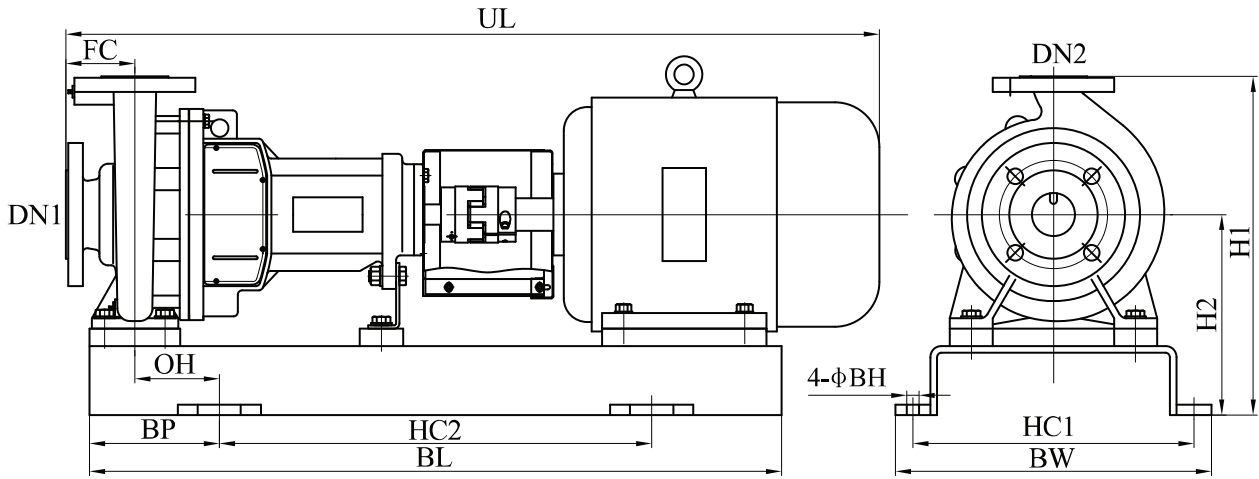

NLF / NLFX / NLFB / NLX / NLN Pump set dimension table 2 pole

Model	Power (kW)	H1	H2	HC1	HC2	BW	BL	BP	BH	OH	UL	FC	DN1	DN2	Total weight (Kg)
50-32-160	3	392	232	296	500	336	750	125	14	72,5	857	80	50	32	94
	4	392	232	296	500	336	750	125	14	72,5	875	80	50	32	100
	5,5	392	232	235	500	365	800	150	14	97,5	941	80	50	32	124
50-32-200	7,5	440	243	340	600	380	860	130	14	77,5	941	80	50	32	139
	11	440	260	380	600	420	950	175	18	121	1077	80	50	32	195
65-40-200	7,5	440	260	325	500	365	800	150	14	97,5	961	100	65	40	140
	11	440	260	380	600	420	950	175	18	121	1097	100	65	40	197
	15	440	260	380	600	420	950	175	18	121	1097	100	65	40	207
65-40-250	18,5	505	280	380	800	420	1080	140	18	73,5	1282	100	65	40	253
	22	505	280	420	800	480	1100	150	18	81,5	1319	100	65	40	189
	30	525	300	460	800	500	1180	190	18	121,5	1379	100	65	40	349
65-40-315	22	550	320	420	800	460	1100	150	18	81,5	1344	125	65	40	301
	30	570	320	455	800	495	1200	200	18	131,5	1412	125	65	40	372
	37	570	320	455	800	495	1200	200	18	131,5	1412	125	65	40	391
	45	590	340	510	800	560	1250	225	22	155	1466	125	65	40	459
65-50-160	4	392	232	296	500	336	750	125	14	72,5	875	80	65	50	102
	5,5	392	232	325	500	365	800	150	14	97,5	941	80	65	50	126
	7,5	392	232	325	500	365	800	150	14	97,5	941	80	65	50	129
80-50-200	11	460	260	380	600	420	950	175	18	121	1097	100	80	50	201
	15	460	260	380	600	420	950	175	18	121	1097	100	80	50	211
	18,5	460	260	380	600	420	950	175	18	121	1137	100	80	50	230
	22	480	280	420	700	460	1000	150	18	96	1194	100	80	50	273
80-50-250	30	525	300	460	800	500	1180	190	18	121,5	1404	125	80	50	351
	37	525	300	460	800	495	1180	190	18	121,5	1404	125	80	50	370
80-50-315	37	625	345	455	800	495	1200	200	18	131,5	1402	125	80	50	402
	45	625	345	510	800	560	1250	225	22	155	1466	125	80	50	466
	55	650	370	575	900	625	1300	200	22	130	1547	125	80	50	566
	75		400	620	800	670	1400	300	22	230	1620	125	80	50	706
80-65-160	5,5	440	260	325	500	365	800	150	14	97,5	961	1000	80	65	135
	7,5	440	260	325	500	365	800	150	14	97,5	961	1000	80	65	138
	11	440	260	380	600	420	950	175	18	121	1097	1000	80	65	195
	15	440	260	380	600	420	950	175	18	121	1097	1000	80	65	205
100-65-200	18,5	505	280	380	800	420	1080	140	18	73,5	1282	1000	100	65	253
	22	505	280	420	800	460	1100	150	18	81,5	1319	1000	100	65	289
	30	525	300	460	800	500	1180	190	18	121,5	1379	1000	100	65	349
	37	525	300	460	800	500	1180	190	18	121,5	1379	1000	100	65	368
100-65-250	45	590	340	510	800	550	1250	225	22	141,5	1466	125	100	65	458
	55	620	370	575	900	625	1350	225	22	141,5	1547	125	100	65	561
	75	650	400	620	800	670	1400	300	22	214	1620	125	100	65	704
100-65-315	90	680	400	620	900	670	1450	275	22	189	1700	125	100	65	781
	110	720	440	710	1000	760	1500	250	22	164	1909	125	100	65	1212
100-80-160	11	460	260	380	800	420	1080	140	18	73,5	1212	100	100	80	209
	15	460	260	380	800	420	1080	140	18	73,5	1212	100	100	80	219
	18,5	460	260	380	800	420	1080	140	18	73,5	1282	100	100	80	239
	22	480	280	420	800	460	1100	150	18	83,5	1319	100	100	80	280
125-100-200	30	600	320	455	800	495	1200	200	18	119	1412	125	125	100	380
	37	600	320	455	800	495	1200	200	18	119	1412	125	125	100	399
	45	620	340	510	800	560	1250	225	22	141,5	1466	125	125	100	463
	55	650	370	575	900	625	1350	225	22	141,5	1547	125	125	100	566
	75	680	400	620	800	670	1400	300	22	214	1620	125	125	100	709
125-100-250	75	680	400	620	800	670	1400	300	22	214	1665	125	125	100	752
	90	680	400	620	900	670	1450	275	22	189	1715	125	125	100	789
	110	720	440	710	1000	760	1500	250	22	164	1924	125	125	100	1220
125-100-315	90	715	440	620	900	670	1450	275	22	189	1715	125	125	100	795
	110	755	440	710	1000	760	1500	250	22	164	1909	125	125	100	1221
		755	440	710	1000	760	1560	280	22	194	2034	125	125	100	1281
	160	755	440	710	1000	760	1560	280	22	194	2034	125	125	100	1401

NLF / NLFX / NLFB / NLX / NLN Pump set dimension table 4 pole

Model	Power (kW)	H1	H2	HC1	HC2	BW	BL	BP	BH	OH	UL	FC	DN1	DN2	Total weight (Kg)
50-32-160	0,55	392	232	296	500	336	700	100	14	47,5	755	80	50	32	63
	0,75	392	232	296	500	336	700	100	14	47,5	755	80	50	32	64
50-32-200	1,1	440	260	296	500	336	750	125	14	72,5	794	80	50	32	90
	1,5	440	260	296	500	336	750	125	14	72,5	819	80	50	32	97
65-40-200	1,1	440	260	325	500	365	750	125	14	72,5	824	100	65	40	92
	1,5	440	260	325	500	365	750	125	14	72,5	849	100	65	40	99
	2,2	440	260	325	500	365	750	125	14	72,5	887	100	65	40	110
65-40-250	3	505	280	376	600	416	920	160	14	95	992	100	65	40	140
65-40-315	4	550	300	405	600	445	900	150	14	85	1045	125	65	40	160
	5,5	505	300	405	600	445	950	175	14	110	1101	125	65	40	182
65-50-160	0,55	392	232	296	500	336	700	100	14	47,5	755	80	65	50	65
	0,75	392	232	296	500	336	700	100	14	47,5	755	80	65	50	66
	1,1	392	232	296	500	336	700	100	14	47,5	794	80	65	50	82
80-50-200	1,5	460	260	325	500	365	750	125	14	72,5	849	100	80	50	103
	2,2	460	260	325	500	365	750	125	14	72,5	877	100	80	50	114
	3	460	260	325	500	365	750	125	14	72,5	877	100	80	50	119
80-50-250	4	505	280	376	600	416	920	160	14	95	1042	125	80	50	148
	5,5	505	280	376	600	416	920	160	14	95	1107	125	80	50	169
80-50-315	5,5	605	325	405	600	445	950	175	14	108,5	1101	125	80	50	186
	7,5	605	325	405	600	445	950	175	14	108,5	1141	125	80	50	200
80-65-160	0,75	440	260	325	500	365	700	100	14	47,5	775	100	80	65	87
	1,1	440	260	325	500	365	750	125	14	72,5	824	100	80	65	90
	1,5	440	260	325	500	365	750	125	14	72,5	849	100	80	65	97
100-65-200	3	505	280	376	600	416	920	160	14	95	992	100	100	65	140
	4	505	280	376	600	416	920	160	14	95	1017	100	100	65	146
	5,5	505	280	376	600	416	920	160	14	95	1082	100	100	65	167
100-65-250	5,5	550	300	420	600	460	980	190	14	110	1111	125	100	65	179
	7,5	550	300	420	600	460	980	190	18	110	1151	125	100	65	198
100-65-315	11	605	325	460	800	500	1120	160	18	80	1267	125	100	65	299
	15	605	325	460	800	500	1120	160	18	80	1307	125	100	65	321
100-80-160	1,5	460	260	340	600	380	860	130	14	65	954	100	100	80	123
	2,2	460	260	340	600	380	860	130	14	65	982	100	100	80	119
	3	460	260	340	600	380	860	130	14	65	982	100	100	80	124
	15	735	380	500	800	540	1150	175	18	94	1317	125	125	80	385
125-100-400	18,5	735	380	500	800	540	1150	175	18	94	1374	125	125	80	420
	22	735	380	510	800	560	1220	210	22	126,5	1404	125	125	80	442
	30	735	380	510	800	560	1220	210	22	126,5	1442	125	125	80	941
	37	755	400	510	800	560	1250	225	22	141,5	1481	125	125	80	548
	4	580	300	420	600	460	900	150	14	70	1045	125	125	100	167
125-100-200	5,5	580	300	420	600	460	980	190	18	110	1111	125	125	100	184
	7,5	580	300	420	800	460	980	190	18	110	1151	125	125	100	203
	11	580	300	420	800	460	1100	150	18	70	1237	125	125	100	254
125-100-250	15	605	325	460	800	500	1120	160	18	80	1322	140	125	100	329
125-100-315	11	665	350	460	800	500	1120	160	18	79	1282	140	125	100	312
	18,5	665	350	460	800	500	1180	190	18	109	1379	140	125	100	368
	22	665	350	460	800	500	1180	190	18	109	1409	140	125	100	385
	30	665	350	510	800	560	1220	210	22	126,5	1457	140	125	100	445
125-100-400	30	735	380	570	800	620	1220	210	22	110	1447	140	125	100	495
	37	755	400	575	900	625	1300	200	22	100	1496	140	125	100	574
150-125-250	45	755	400	575	900	625	1300	200	22	100	1531	140	125	100	603
	11	705	350	460	800	500	1120	160	18	79	1282	140	150	125	308
	15	705	350	460	800	500	1120	160	18	79	1322	140	150	125	335
	18,5	705	350	460	800	500	1180	190	18	109	1379	140	150	125	366
150-125-315	22	705	350	460	800	500	1180	190	18	109	1409	140	150	125	383
	30	735	380	570	800	620	1220	210	22	110	1447	140	150	125	481
150-125-400	37	755	400	575	900	625	1300	200	22	100	1496	140	150	125	558
	45	835	435	575	900	625	1300	200	22	100	1531	140	150	125	612
	55	835	435	575	900	625	1350	225	22	125	1592	140	150	125	670
200-150-315	75	835	435	620	800	670	1400	300	22	200	1665	140	150	125	827
	37	835	435	620	800	670	1400	300	22	200	1656	160	200	150	613
	45	835	435	595	900	645	1500	300	22	200	1691	160	200	150	651
200-150-400	55	835	435	595	900	645	1500	300	22	200	1752	160	200	150	723
	75	835	435	625	1000	675	1600	300	22	200	1835	160	200	150	879
	75	885	435	625	1000	675	1600	300	22	200	1835	160	200	150	932
250-200-315	90	885	435	625	1000	675	1600	300	22	200	1885	160	200	150	1028
	110	885	435	710	1200	760	1700	250	22	150	2124	160	200	150	1398
	37	885	435	620	800	670	1400	300	22	200	1676	180	250	200	664
250-200-400	45	885	435	595	900	645	1500	300	22	200	1711	180	250	200	702
	55	885	435	595	900	645	1500	300	22	200	1772	180	250	200	768
	75	885	435	625	1000	675	1600	300	22	200	1855	180	250	200	913
	90	950	500	625	1000	675	1600	300	22	200	1905	180	250	200	1087
300-250-315	110	950	500	710	1200	760	1700	250	22	150	2144	180	250	200	1473
	132	950	500	710	1200	760	1750	275	22	175	2244	180	250	200	1568
	160	950	500	710	1200	760	1750	275	22	175	2244	180	250	200	1637
300-250-400	75	930	475	810	750	850	1250	250	22	90	1356	225	300	250	1120
	90	930	475	810	750	850	1250	250	22	90	1406	225	300	250	1182
300-250-400	110	930	475	810	750	850	1250	250	22	90	1743	225	300	250	1518
	132	1025	525	810	900	850	1400	250	22	90	1721	225	300	250	1676
	160	1025	525	810	900	850	1400	250	22	90	1721	225	300	250	1777
200	1025	525	810	900	850	1400	250	22	90	1721	225	300	250	1853	

NF / NFX / NFB / NX / NN Pump set dimension

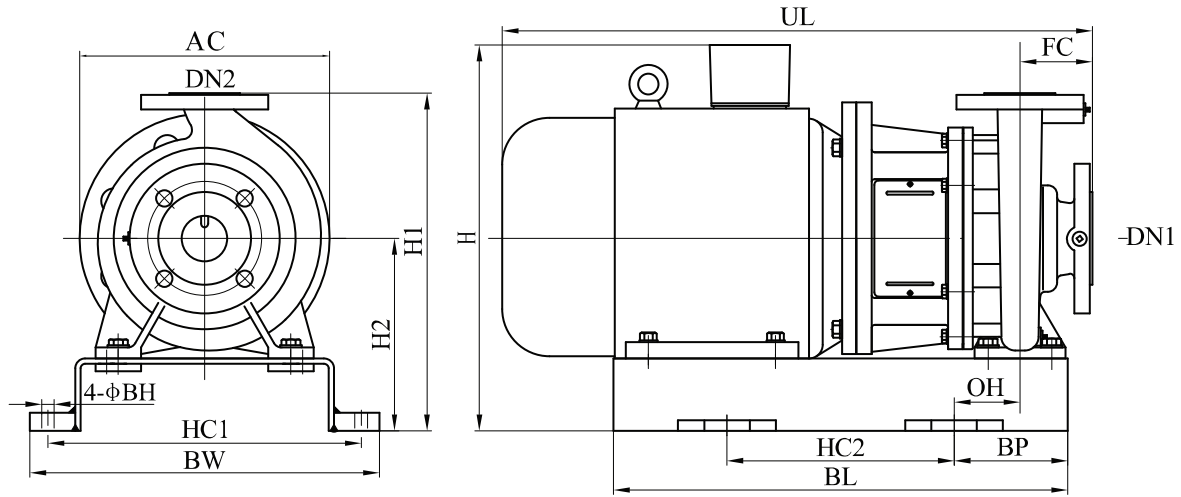

NF / NFX / NFB / NX / NN Pump set dimension table 2 pole

Model	Power (kW)	H	H1	H2	HC1	HC2	BW	BL	BP	BH	OH	UL	FC	DN1	DN2	Weight (Kg)
50-32-160	3	382	372	212	306	250	336	450	100	14	47,5	563	80	50	32	75
	4	400	372	212	306	250	336	450	100	14	47,5	578	80	50	32	81
	5,5	425	372	212	335	300	365	500	100	14	47,5	650	80	50	32	105
50-32-200	7,5	453	420	240	350	300	380	500	100	14	46	650	80	50	32	120
	11	500	420	240	390	350	420	600	125	18	71	787	80	50	32	175
65-40-200	7,5	453	420	240	335	300	365	500	100	14	47,5	670	100	65	40	120
	11	500	420	240	390	350	420	600	125	18	71	807	100	65	40	177
65-40-250	15	500	420	240	390	350	420	600	125	18	71	807	100	65	40	187
	18,5	520	485	260	390	400	420	660	130	18	63,5	865	100	65	40	222
	22	535	485	260	430	400	460	700	150	18	81,5	895	100	65	40	257
65-40-315	30	585	505	280	470	450	500	750	150	18	81,5	967	100	65	40	318
	22	555	530	280	430	400	460	700	150	18	81,5	920	125	65	40	270
	30	585	530	280	465	500	495	800	150	18	81,5	992	125	65	40	340
65-50-160	37	585	530	280	465	500	495	800	150	18	81,5	992	125	65	40	359
	45	640	555	305	520	500	560	820	160	22	90	1042	125	65	40	428
	4	400	372	212	306	250	336	450	100	14	47,5	578	80	65	50	83
80-50-200	5,5	425	372	212	335	300	365	500	100	14	47,5	650	80	65	50	107
	7,5	425	372	212	335	300	365	500	100	14	47,5	650	80	65	50	110
	11	500	440	240	390	350	420	600	125	18	71	807	100	SO	50	181
80-50-250	15	500	440	240	390	350	420	600	125	18	71	807	100	SO	50	191
	18,5	500	440	240	390	400	420	660	130	18	76	862	100	80	50	211
	22	535	460	260	430	400	460	700	150	18	96	892	100	80	50	254
80-50-315	30	585	505	280	470	450	500	750	150	18	81,5	992	125	SO	50	320
	37	585	505	280	470	450	500	750	150	18	81,5	992	125	80	50	339
	37	610	585	305	465	500	495	800	150	18	81,5	992	125	80	50	370
80-65-160	45	640	585	305	520	500	560	820	160	22	90	1042	125	80	50	434
	55	715	630	350	585	550	625	950	200	22	130	1156	125	80	50	534
	75	780	660	380	630	600	670	1000	200	22	130	1231	125	80	50	675
100-65-200	5,5	453	420	240	335	300	365	500	100	14	47,5	670	100	80	65	115
	7,5	453	420	240	335	300	365	500	100	14	47,5	670	100	80	65	118
	11	500	420	240	390	350	420	600	125	18	71	807	100	80	65	175
	15	500	420	240	390	350	420	600	125	18	71	807	100	80	65	185
100-65-250	18,5	520	485	260	390	400	420	660	130	18	63,5	865	100	100	65	222
	22	535	485	260	430	400	460	700	150	18	81,5	895	100	100	65	257
	30	585	505	280	470	450	500	750	150	18	81,5	967	100	100	65	318
	37	585	505	280	470	450	500	750	150	18	81,5	967	100	100	65	337
100-65-315G	45	640	555	305	520	500	560	820	160	22	90	1042	125	100	65	426
	55	715	600	350	585	550	625	950	200	22	116,5	1156	125	100	65	529
	75	780	630	380	630	600	670	1000	200	22	114	1231	125	100	65	673
100-80-160	75	780	660	380	630	600	670	1000	200	22	114	1245	125	100	65	693
	90	780	660	380	630	600	670	1100	250	22	164	1295	125	100	65	730
100-80-200	110	945	695	415	720	600	760	1100	250	22	164	1530	125	100	65	1161
	11	500	440	240	390	400	420	660	130	18	63,5	810	100	100	80	177
	15	500	440	240	390	400	420	660	130	18	63,5	810	100	100	80	187
	18,5	500	440	240	390	400	420	660	130	18	63,5	865	100	100	BO	207
	22	535	460	260	430	400	460	700	150	18	83,5	895	100	100	80	248

NF / NFX / NFB / NX / NN Pump set dimension table 2 pole

Model	Power (kW)	H	H1	H2	HC1	HC2	BW	BL	BP	BH	OH	UL	FC	DN1	DN2	Weight (Kg)
125-100-200	30	585	560	280	465	500	495	800	150	1\$	69	992	125	125	100	349
	37	585	560	280	465	500	495	800	150	18	69	992	125	125	100	368
	45	640	585	305	520	500	560	820	160	22	76,5	1042	125	125	100	431
	55	715	630	350	585	550	625	950	200	22	116,5	1156	125	125	100	534
125-100-250	75	780	660	380	630	600	670	1000	200	22	114	1231	125	125	100	678
	75	780	660	380	630	600	670	1000	200	22	114	1265	140	125	100	701
	90	780	660	380	630	600	670	1100	250	22	164	1315	140	125	100	738
125-100-315	110	945	695	415	720	600	760	1100	250	22	164	1523	140	125	100	1169
	90	780	695	380	630	600	670	1100	250	22	164	1310	140	125	100	744
	110	945	730	415	720	600	760	1100	250	22	164	1545	140	125	100	1170
	132	945	730	415	720	700	760	1220	260	22	174	1655	140	125	100	1230
	160	945	730	415	720	700	760	1220	260	22	174	1655	140	125	100	1350

NF / NFX / NFB / NX / NN Pump set dimension table 4 pole

Model	Power (kW)	H	H1	H2	HC1	HC2	BW	BL	BP	BH	OH	UL	FC	DN1	DN2	Weight (Kg)
50-32-160	0,55	352	372	212	306	250	336	400	75	14	22,5	483	80	50	32	44
	0,75	352	372	212	306	250	336	400	75	14	22,5	483	80	50	32	45
50-32-200	1,1	400	420	240	306	250	336	400	75	14	22,5	498	80	50	32	71
	1,5	400	420	240	306	250	336	400	75	14	22,5	523	80	50	32	78
65-40-200	1,1	400	420	240	335	250	365	400	75	14	22,5	518	100	65	40	73
	1,5	400	420	240	335	250	365	400	75	14	22,5	543	100	65	40	80
	2,2	410	420	240	335	250	365	450	100	14	47,5	583	100	65	40	91
65-40-250	3	430	485	260	386	300	416	500	100	14	35	591	100	65	40	109
65-40-315	4	468	530	280	415	300	445	500	100	14	35	631	125	65	40	128
	5,5	493	530	280	415	300	445	500	100	14	35	687	125	65	40	151
65-50-160	0,55	352	372	212	306	250	336	400	75	14	22,5	483	80	65	50	46
	0,75	352	372	212	306	250	336	400	75	14	22,5	483	80	65	50	47
	1,1	372	372	212	306	250	336	400	75	14	22,5	498	80	65	50	63
80-50-200	1,5	400	440	240	335	250	365	400	75	14	22,5	543	100	80	50	84
	2,2	410	440	240	335	250	365	450	100	14	47,5	583	100	80	50	95
	3	410	440	240	335	250	365	450	100	14	47,5	583	100	80	50	100
80-50-250	4	448	485	260	386	300	416	500	100	14	35	631	125	80	50	116
	5,5	473	485	260	386	300	416	500	100	14	35	687	125	80	50	137
80-50-315	5,5	518	585	305	415	350	445	550	100	18	33,5	687	125	80	50	155
	7,5	518	585	305	415	350	445	550	100	18	33,5	727	125	80	50	169
80-65-160	0,75	380	420	240	335	250	365	400	75	14	22,5	503	100	80	65	67
	1,1	400	420	240	335	250	365	400	75	14	22,5	518	100	80	65	71
	1,5	400	420	240	335	250	365	400	75	14	22,5	543	100	80	65	78
100-65-200	3	430	485	260	386	300	416	500	100	14	35	591	100	100	65	109
	4	448	485	260	386	300	416	500	100	14	35	606	100	100	65	114
	5,5	473	485	260	386	300	416	500	100	14	35	662	100	100	65	135
100-65-250	5,5	493	530	280	430	350	460	550	100	14	20	687	125	100	65	147
	7,5	493	530	280	430	350	460	550	100	18	20	727	125	100	65	166
100-65-315	11	565	585	305	470	400	500	700	150	18	70	854	125	100	65	249
	15	565	585	305	470	400	500	700	150	18	70	909	125	100	65	270
100-80-160	1,5	400	440	240	350	250	380	410	105	14	40	536	100	100	80	76
	2,2	410	440	240	350	300	380	500	100	14	35	591	100	100	80	87
	3	410	440	240	350	300	380	500	100	14	35	591	100	100	80	92
125-8-400	15	620	715	360	510	450	540	750	150	18	68	911	125	125	80	334
	18,5	635	715	360	510	450	540	750	150	18	66,5	941	125	125	80	369
	22	635	715	360	520	450	560	750	150	22	76,5	981	125	125	80	391
	30	665	715	360	520	500	560	820	160	22	68	1015	125	125	80	440
	37	695	715	360	520	500	560	820	160	22	76,5	1058	125	125	80	498
125-100-200	4	468	560	280	430	300	460	500	100	14	20	631	125	125	100	136
	5,5	493	560	280	430	350	460	550	100	18	20	687	125	125	100	152
	7,5	493	560	280	430	350	460	550	100	18	20	727	125	125	100	171
	11	540	560	280	430	400	460	650	125	18	45	835	125	125	100	222
125-100-250G	11	565	585	305	470	400	500	700	150	18	70	924	140	125	100	258
125-100-250	15	565	585	305	470	400	500	700	150	18	70	924	140	125	100	278
125-100-315G	15	590	645	330	470	400	500	700	150	18	69	869	140	125	100	281
125-100-315	11	590	645	330	470	400	500	700	150	18	69	869	140	125	100	261
	18,5	605	645	330	470	450	500	750	150	18	69	954	140	125	100	317
	22	605	645	330	470	450	500	750	150	18	69	994	140	125	100	335
	30	635	645	330	520	500	560	820	160	22	76,5	1028	140	125	100	394
125-100-400	30	665	715	360	580	500	620	800	150	22	50	1028	140	125	100	444
	37	715	735	380	585	550	625	950	200	22	100	1071	140	125	100	523
	45	715	735	380	585	550	625	950	200	22	100	1101	140	125	100	552

NF / NFX / NFB / NX / NN Pump set dimension table 4 pole

Model	Power (kW)	H	H1	H2	HC1	HC2	BW	BL	BP	BH	OH	UL	FC	DN1	DN2	Weight (Kg)
150-125-200G	5,5	543	630	330	470	350	500	570	100	18	20	721	140	150	125	168
	7,5	543	630	330	470	350	500	570	100	18	20	761	140	150	125	180
	11	590	630	330	470	400	500	700	150	18	69	869	140	150	125	235
150-125-250	11	590	685	330	470	400	500	700	150	18	69	869	140	150	125	257
	15	590	685	330	470	400	500	700	150	18	69	924	140	150	125	284
	18,5	605	685	330	470	450	500	750	150	18	69	954	140	150	125	315
	22	605	685	330	470	450	500	750	150	18	69	994	140	150	125	333
150-125-315	30	665	715	360	580	500	620	800	150	22	50	1028	140	150	125	430
	37	715	735	380	585	550	625	950	200	22	100	1071	140	150	125	507
150-125-400	45	750	815	415	585	550	625	950	200	22	100	1103	140	150	125	561
	55	780	815	415	585	550	625	950	200	22	100	1187	140	150	125	620
	75	815	815	415	630	600	670	1000	200	22	100	1262	140	150	125	776
200-150-250G	15	620	735	360	580	500	620	800	150	22	50	956	160	200	150	299
	18,5	635	735	360	580	500	620	800	150	22	50	988	160	200	150	337
	22	635	735	360	580	500	620	800	150	22	50	1026	160	200	150	360
200-150-315	30	665	735	360	580	500	620	800	150	22	50	1048	160	200	150	426
	37	750	815	415	605	500	670	900	200	22	100	1116	160	200	150	541
	45	750	815	415	605	500	645	900	200	22	100	1146	160	200	150	579
	55	780	815	415	605	600	645	1000	200	22	100	1254	160	200	150	650
200-150-400	75	815	815	415	630	600	675	1100	250	22	150	1329	160	200	150	806
	90	815	865	415	630	600	675	1100	250	22	150	1379	160	200	150	859
	110	945	865	415	720	700	760	1220	260	22	160	1614	160	200	150	1325
	132	1010	930	480	720	700	760	1220	260	22	160	1744	180	250	200	1495
250-200-315	37	750	865	415	605	500	670	900	200	22	100	1136	180	250	200	592
	45	750	865	415	605	500	645	900	200	22	100	1166	180	250	200	630
	55	780	865	415	605	600	645	1100	250	22	150	1274	180	250	200	695
250-200-400	75	815	865	415	630	600	675	1100	250	22	150	1349	180	250	200	840
	90	845	930	480	630	600	675	1100	250	22	150	1399	180	250	200	1015
	110	1010	930	480	720	750	760	1250	250	22	150	1634	180	250	200	1400
	132	1010	930	480	720	700	760	1220	260	22	160	1744	180	250	200	1495
300-250-315	160	1010	930	480	720	700	760	1220	260	22	160	1744	180	250	200	1564
	75	930	930	475	810	750	850	1250	250	22	90	1356	225	300	250	1120
	90	930	930	475	810	750	850	1250	250	22	90	1406	225	300	250	1182
300-250-400	110	1005	930	475	810	750	850	1250	250	22	90	1743	225	300	250	1518
	110	1055	1025	525	810	750	850	1250	250	22	90	1611	225	300	250	1582
	132	1055	1025	525	810	900	850	1400	250	22	90	1721	225	300	250	1676
300-250-400	160	1055	1025	525	810	900	850	1400	250	22	90	1721	225	300	250	1777
	200	1055	1025	525	810	900	850	1400	250	22	90	1721	225	300	250	1853

NF / NFX / NFB / NX / NN

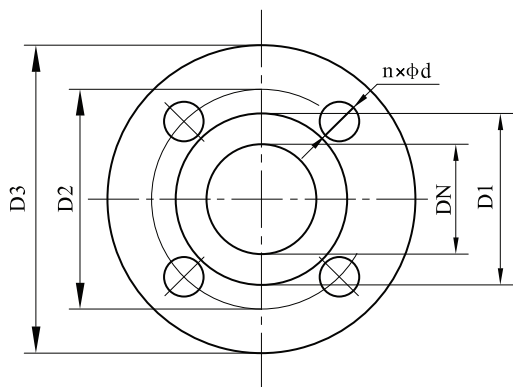

DN	D1	D2	D3	n	d
32	78	100	140	4	18
50	102	125	165	4	18
65	122	145	185	4	18
80	133	160	200	8	18
100	158	180	220	8	18
125	184	210	250	8	18
150	212	240	285	8	22
200	268	295	340	12	22
250	320	355	405	12	26
300	370	410	460	12	27
132	945	730	415	720	700
160	945	730	415	720	700

BE
PUMPING
PARTNERS

www.alphadynamic.eu

AlphaDynamic Pumps SA

Production Plant - Greece
Inofita Industrial area
59th km Nat.Road Athens - Lamia
GR 320 11 Inofita Viotia, Greece

Tel +30 215 215 9520 , +30 215 215 9580
Email: Sales@alphadynamic.eu



hydroo[®]