

The ADV 130 vertical centrifugal pump are high-performance pump for fixed installations with pump immersed directly in the tank and operated by a direct-drive electric motor (max 3000 rpm) for fast fluid drainage.



EAC CE

Technical Data

Construction Materials	PP-PVDF
Max.capacity	30 m ³ /h
Max Head	20 m
Max Temperature	PP 60°C - PVDF 90°C
Max Viscosity	500 cPs
Max diameter of passing solids	6 mm
Intake / delivery connections	2" M x 1 1/2" M-DN50 X DN40 on request
Motor	3 HP 380V3/50Hz/2800 rpm

Description

Vertical centrifugal pump with bracket ADV 130 is made of thermoplastic materials (PP and PVDF) and are suitable to pump high corrosive liquids with solids. Pump series ADV are available with different column lengths from 500 mm to 1250 mm. The open impeller allows pumping even with very dirty liquids having viscosity of up to 500 cps and small suspended solids. ADV 130 vertical centrifugal pump consists of a solid pump casing and a column fitted to the base plate supporting the lantern that in turn supports the electric motor. The direct-drive motor is connected by a flexible coupling on the pump shaft. The open impeller is fitted to the other end of the shaft that is supported by a radial bearing. This pump's special design allows the motor to be stripped without the need to disconnect the pump from the system.

POS	DESCRIPTION	MATERIAL
1	PUMP HEAD	PP or PVDF
2	O-RING	EPDM or VITON
3	SHAFT COVERING GUIDE	PP or PVDF
4	COVER	PP or PVDF
5	BUSHING	PTFEC
6	WEAR BUSHING	Alumina
7	IMPELLER	PP or PVDF
8	COLUMN	PP or PVDF

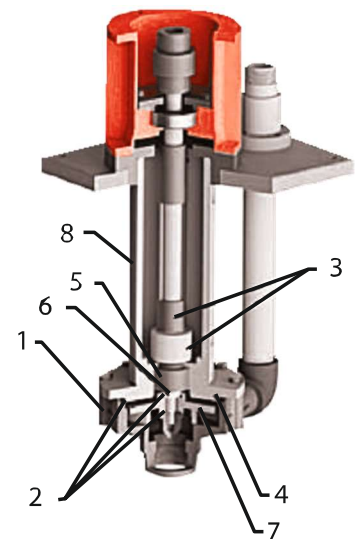

Installation

ADV Vertical centrifugal pumps should only be installed with the shaft positioned vertically and the pump immersed in the tank. Suitable devices should be fitted to avoid dry running and/or the formation of a vortex and possible air suction. These pumps should only operate whilst filled. Running dry or with air bubbles can cause damage to the internal bushing.

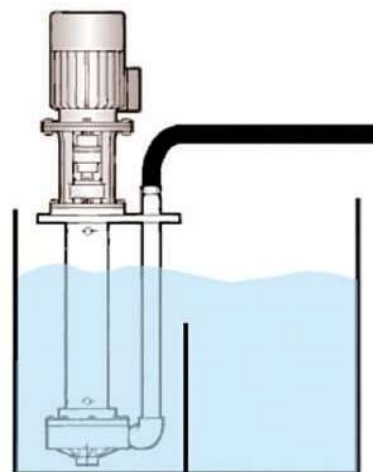

Application Sectors

Chemical Industry, Galvanic & Electronic Industry, Water Treatment Industry



CHEMICAL INDUSTRY



WATER AND SLUDGE
TREATMENT



GALVANIC AND ELECTRONIC INDUSTRY

Performance

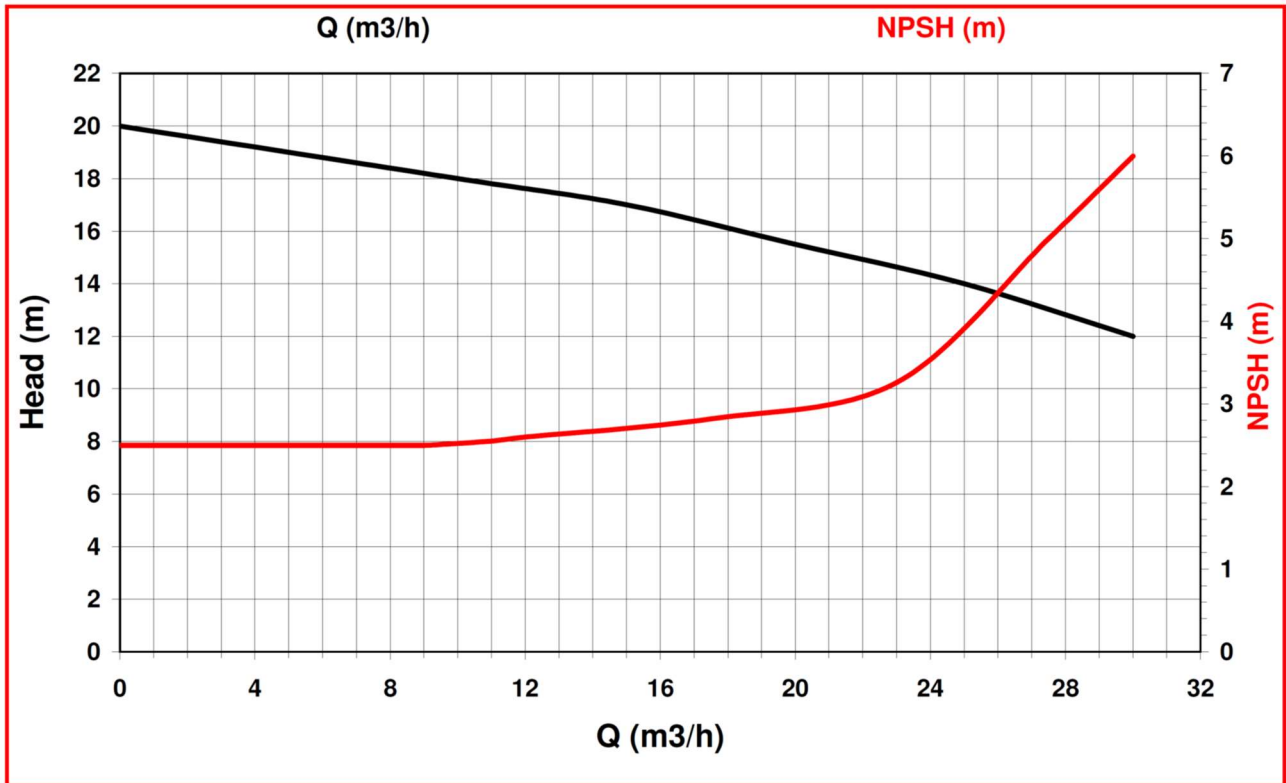

Dimensions Column length: 500 - 1250 mm

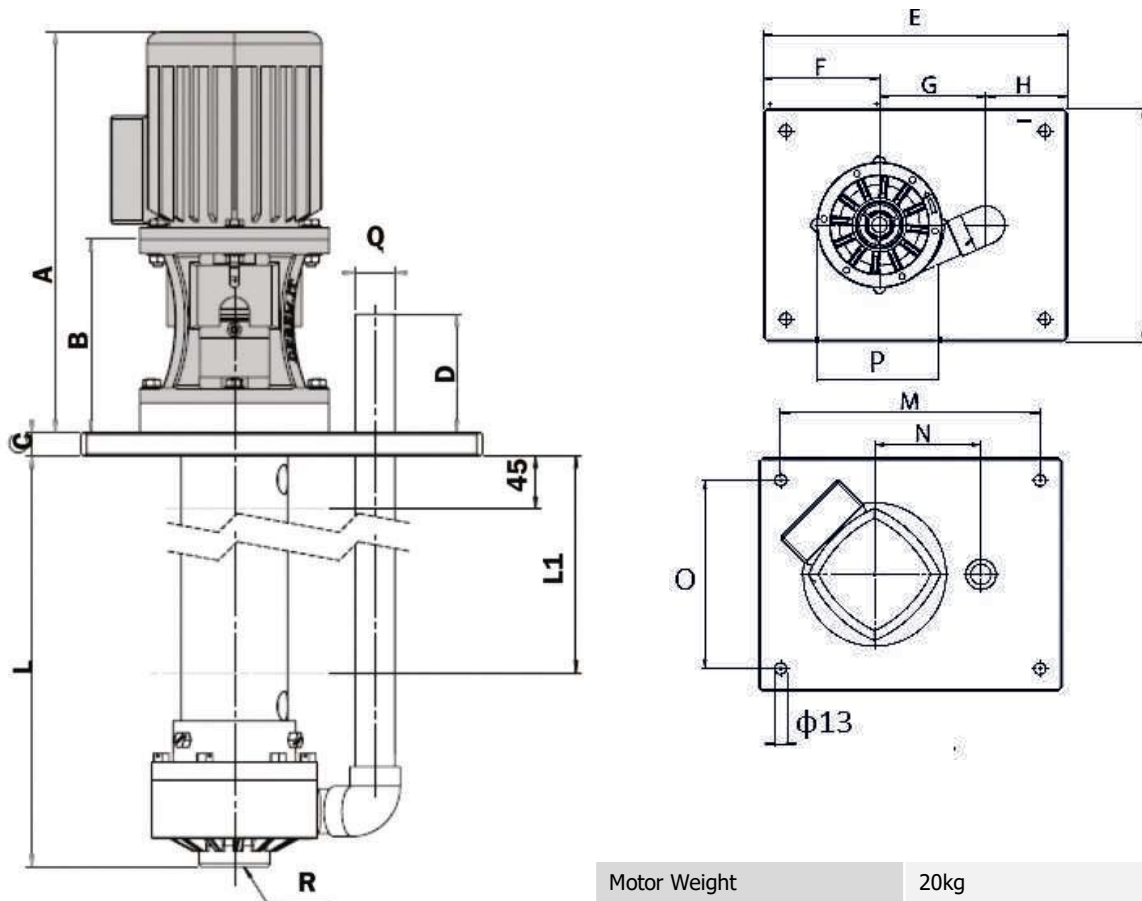

Motor Weight	20kg
Column Weight L=500mm	PP 15Kg - PVDF 16Kg
Column Weight L=800mm	PP 19Kg - PVDF 20Kg
Column Weight L=1000mm	PP 22Kg - PVDF 23Kg
Column Weight L=1200mm	PP 24Kg - PVDF 25Kg

Pump Type	Motor Flange B5	Dimensions -mm-																
		HP	A	B	L	C	D	E	F	G	H	I	M	N	O	P	Q	R
ADV 130	90	3.0	467	220	500-1250	25	125	360	135	165	60	300	310	165	250	Φ203	1 1/2"	2'



We Make The Difference

Production Plant - Greece

Inofita Industrial area
59th km Nat.Road Athens - Lamia
GR 320 11 Inofita Viotia, Greece
Tel: +30 215 215 9520, +30 215 215 9580
email: sales@alphadynamic.eu
www.alphadynamic.eu