

## Ruby 112

Construction materials: **AISI 316**

New pump line with a completely new design offering enhanced pumping capabilities. The modernized design ensures even higher performance while maintaining efficiency.

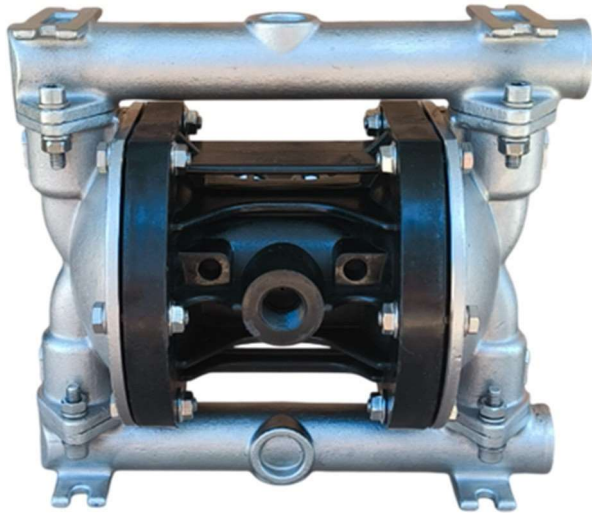

## Benefits

- Optimal performance
- Economical air consumption with ecological design
- High efficiency in pressure/capacity
- Oil free operation
- No freezing
- New air valve design with fully controlled air flow
- Easy to disassemble and reassemble
- New generation PTFE diaphragms with an integrated design (compound) for long-life operation
- Ideal for abrasive, viscous, and shear sensitive media
- Potential to be submersible (on request)
- Possibility of use in dirty environments due to their enclosed design
- Easy manifold reversal
- Automatic suction
- Twin manifold option (two suction and two delivery ports)
- Excellent performance and value for money

## Ruby 112 composition codes

Pump model	Pump Body	Center block	Diaphragms	Ball Seats	Balls	O-ring	Other Options
Ruby 112	S: AISI 316	P: PP PC: PP+CF	T: Compound PTFE+EPDM Conductive	S: AISI316 V: PVDF	T: PTFE S: AISI 316	T: PTFE F: FKM	D: Twin Manifold

## Ruby Innovative Oil-Free Air Valve

The heart of the Ruby pump is our innovative new air valve design. In response to modern demands for high-quality products with a strong focus on environmental protection, the Air Valve of the Ruby Diaphragm Pumps has been designed to offer:

- Oil-free operation
- Low maintenance requirements
- Unaffected by minor contamination of compressed air
- Significant energy saving
- Nonfreezing operation
- Operates in external environments
- No dead center
- Long lifespan
- High reliability

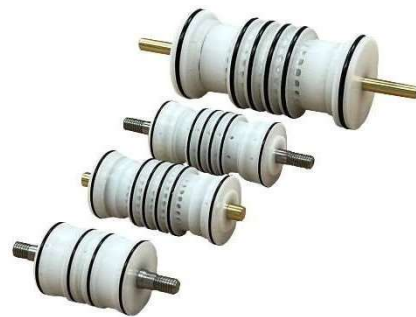

## Advance Unified Diaphragms Featuring:

- Easy installation and maintenance
- Excellent service life
- Reduced inventory costs
- Improved performance
- Greater displacement per cycle
- No center hole eliminating potential leak paths
- No need to secure the main axis
- Tool-free assembly and disassembly



## Advance Unified Diaphragm offers:

The prominences decrease the stretching of the PTFE during the regression and prevent it from cracking.

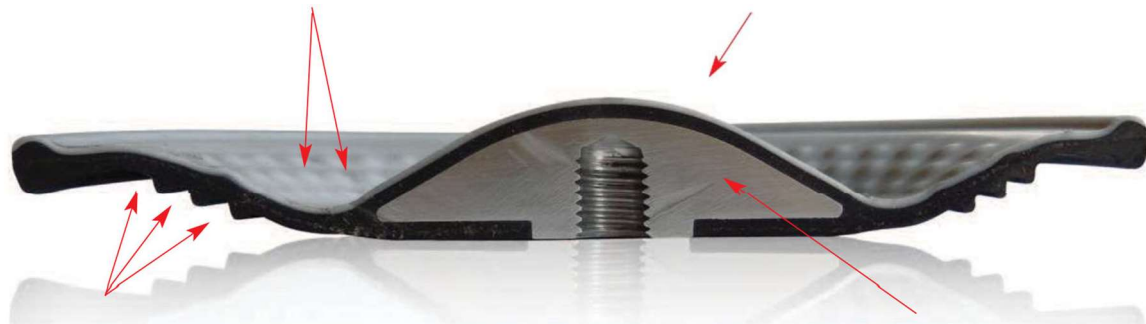

Innovative conical shape ideal for optimal performance and life, low pressure requirements for start-up, ideal suction



Innovative diaphragm support side, offers flexibility, long life and protects from cavitation

Special internal plate supports your diaphragm in every movement

## Technical data

ATEX Certification	 STANDARD : II 3/3 G/D Ex h IIB T4 Gc/Dc CONDUCT : II 2G Ex h IIC T4 Gb II 2D Ex h IIC T135 °C Db I M2 Ex h I Mb Type Examination HAMILTON JSHP 025 ATEX 0025X	
Construction Materials	AISI 316	
Diaphragms	T: Compound PTFE + Backup (EPDM Conductive)	
Intake/delivery connections	1/2" BSP G	
Air connection	3/8"	
*Max. flow rate	32 L/min	
*Max. flow pressure	8 bar	
Operating pressure	Min. 2 bar - Max.8 bar	
Max. suction head	5 m	
Max. size of solids	3.0 mm	
Max. operating Temperature	95°C	
Weight	4.7 Kg	

\* The curves and performance values refer to pumps with submerged suction and a free delivery outlet with water at 20°C, and vary according to the construction material.

## Performance

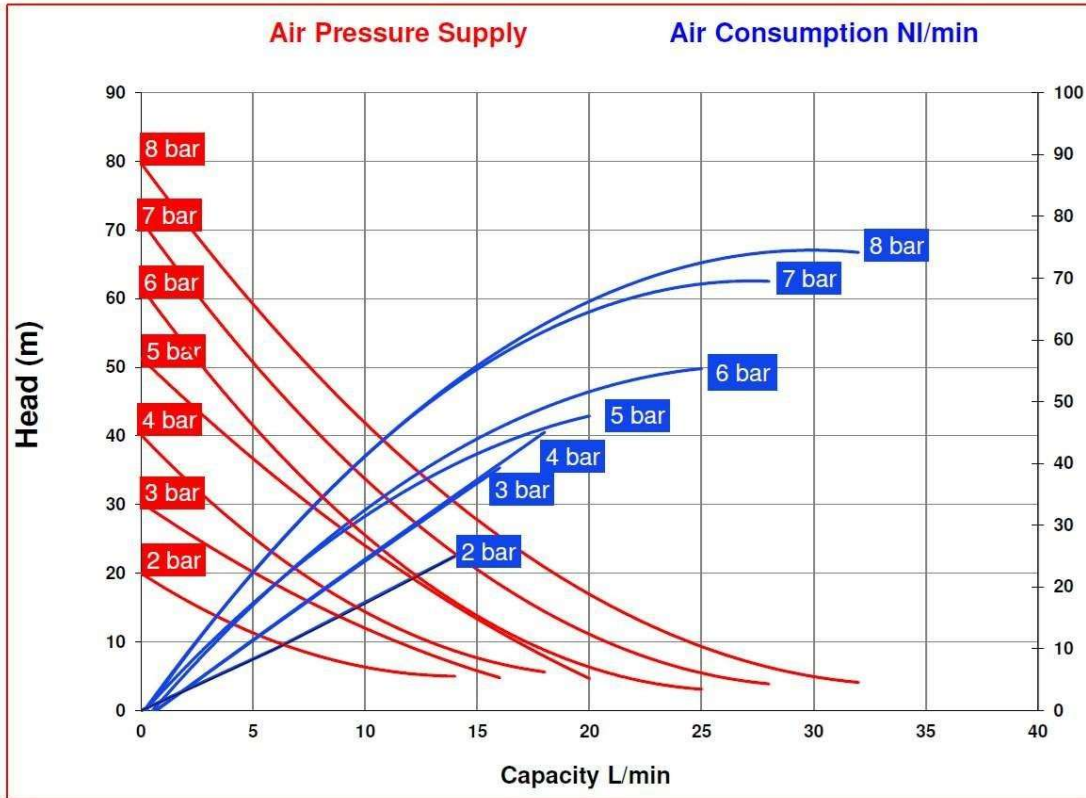

## Dimensions

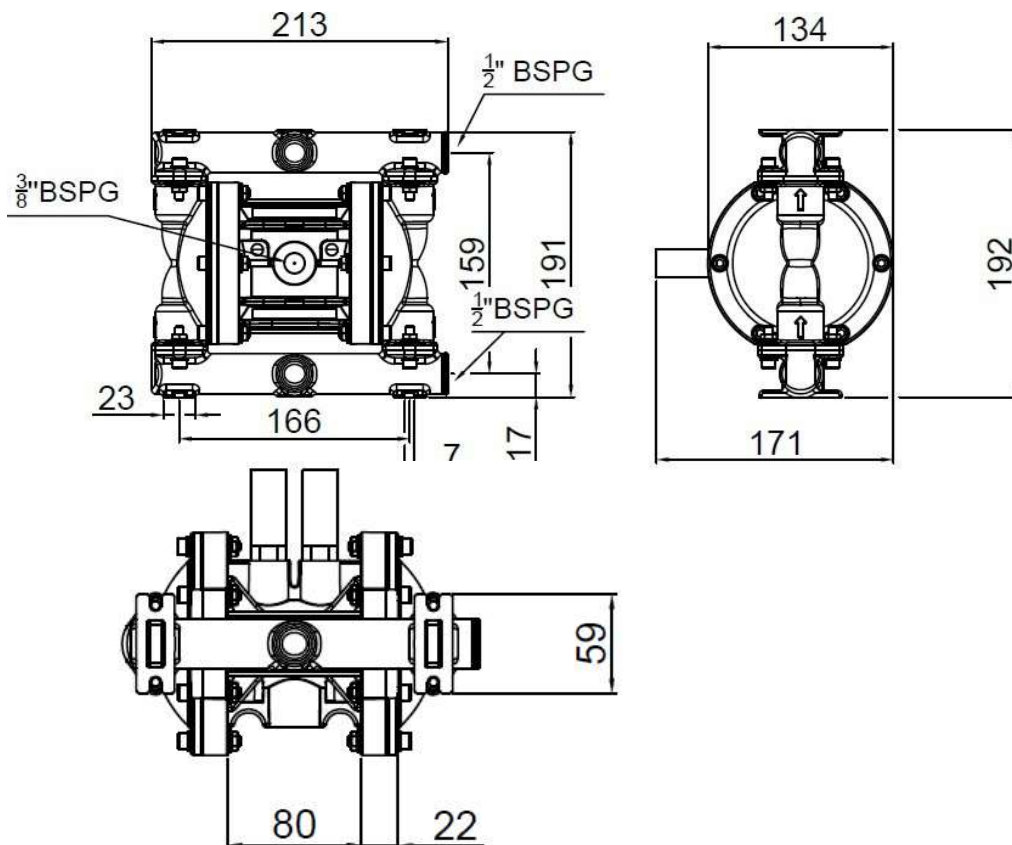



**Production Plant - Greece**  
Inofita Industrial area  
59th km Nat.Road Athens- Lamia  
GR 320 11 Inofita Viotia, Greece  
Tel +30 215 215 9520 , +30 215 215 9580  
Email: Sales@alphadynamic.eu  
www.alphadynamic.eu

[www.alphadynamic.eu](http://www.alphadynamic.eu)